

# BOOK'16

HEATING PRODUCTS DESIGNED  
AND DEVELOPED BY FOURSTEEL®

**FOURSTEEL®**

[ heating products factory ]



## FOURSTEEL® corporate

A Foursteel é uma empresa portuguesa fabricante de radiadores de design de conceitos contemporâneos e minimalistas.

A aposta em I&D e em especial o foco nas necessidades do mercado em colaboração com arquitetos e designers têm permitido à Foursteel desenvolver soluções de produtos de aquecimento eficientes com estética apurada, sustentando o seu desenvolvimento a nível nacional e internacional.

Foursteel® Heating Products Factory

Edição Book'16 Impresso em Aveiro, Portugal

© Foursteel, Aveiro, 2016, Todos os direitos reservados

A Foursteel® reserva o direito de alteração, sem aviso prévio, de todos os produtos e desenhos que constem neste catálogo. Todos os produtos Foursteel® são adaptáveis em termos de potências e dimensões.

# RADIADORES TOALHEIROS

## MINIMALIST COLLECTION

- 08 Minimal
- 14 Minimal X
- 20 M Tube
- 24 M Tube Square
- 28 M Tube Round
- 30 M Slim
- 34 M Slim Square
- 38 Fourslim by Architects
- 44 Fourslim on/off
- 46 Fourslim Square
- 52 Fourslim Square on/off
- 54 Fourslim Square LED
- 56 Skinny

## THE EVOLUTION

- 62 Steel Glam
- 74 Steel Elegance
- 78 Fourfoz
- 84 Steel Wave
- 88 Steel Stone

## FIRST COLLECTION

- 94 Steel Classic
- 98 Steel Glamour
- 102 Steel Style

## REWIND COLLECTION

- 108 Empress
- 114 Old Beauty
- 120 Remind
- 124 Floor Remind
- 130 Retro special
- 136 Old Grace
- 140 Royalty

## NEW COLLECTION

New Slim	146
New Square	150
New Q	154

## BASIC LINE

Basic Line	160
------------	-----

## DESIGN COLLECTION

Diamond	168
Diamond XS	172
Arena	176
Arena Table	182

## ROOM RADIATORS

Curve	186
D Ligne	194
Divine	200
Linear	206
Plano Move	212
Plano Pure	218
Plano Pure on/off	224
Plano +	226
Plano	232

## ACESSÓRIOS

Domotic Touch	240
Mimoo Switch	244
Elementos Elétricos	246
Válvulas e Retentores	248
Outros Acessórios	256

**NOTA:**

**QUANDO NÃO IDENTIFICADO A POSIÇÃO DO ELEMENTO ELÉTRICO  
SERÁ SEMPRE COLOCADO DO LADO INFERIOR DIREITO**

**CORES RAL: cores sujeitas a confirmação.**

**BRANCO: RAL 9016 (RAL usado por definição)**

# MINIMALIST COLLECTION

MINIMAL	08
MINIMAL X	14
M TUBE	20
M TUBE SQUARE	24
M TUBE ROUND	28
M SLIM	30
M SLIM SQUARE	34
FOURSLIM BY ARCHITECTS	38
FOURSLIM ON/OFF	44
FOURSLIM SQUARE	46
FOURSLIM SQUARE ON/OFF	52
FOURSLIM SQUARE LED	54
SKINNY	56

# MINIMAL

SECA-TOALHAS

ARQUITETO: MANUEL AIRES MATEUS

Conceito minimalista, o toalheiro elétrico Minimal foi criado e desenvolvido em parceria com o Arq.º Manuel Aires Mateus para o projeto Condomínio Palácio Condes de Murça em Lisboa.







# MINIMAL



VISTA DE CIMA

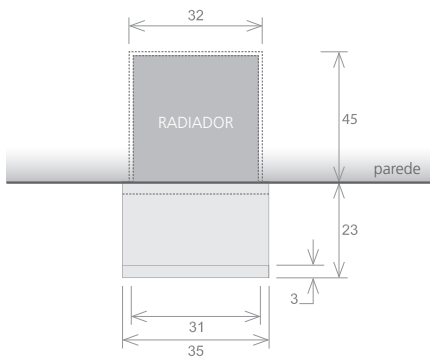

VISTA DE FRENTE



VISTA LATERAL





MATERIAL aço inox

ACABAMENTOS



POLIDO



ESCOVADO



PRETO



BRANCO



COR RAL

ACABAMENTO EM TITÂNIO \*



OURO



OURO VELHO



COBRE

VISTA DE FRENTE

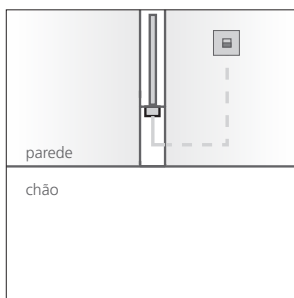

VISTA LATERAL

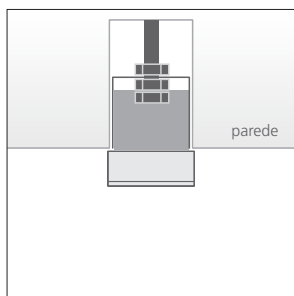
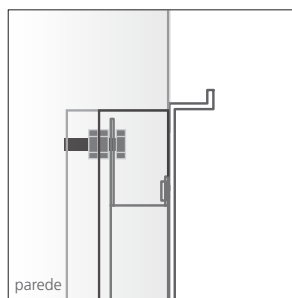

VISTA DE CIMA



MIMOO  
SWITCH



DOMOTIC  
TOUCH

modelo	M 900	M 1200	M 1400	M 1800
altura (mm) a	900	1200	1400	1800
largura total (mm) b	35	35	35	35
profundidade (mm) c	23	23	23	23
capacidade (l)	0,6	0,8	1,0	1,3
elétrico (W)	100	150	150	200



# MINIMAL X



# MINIMAL X

MATERIAL aço inox

## ACABAMENTOS



POLIDO



ESCOVADO



PRETO



BRANCO



COR RAL

## ACABAMENTO EM TITÂNIO \*



OURO



OURO VELHO



COBRE





MIMOO  
SWITCH



DOMOTIC  
TOUCH

modelo		MX 900	MX 1200	MX 1400	MX 1800
altura (mm)	a	900	1200	1400	1800
largura total (mm)	b	50	50	50	50
profundidade (mm)	c	50	50	50	50
capacidade (l)		0,6	0,8	1,0	1,3
elétrico (W)		40	100	150	150

# MINIMAL X



VISTA DE CIMA

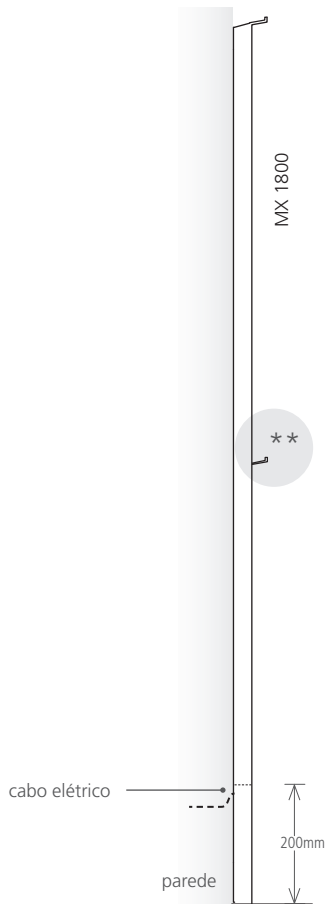

VISTA DE FRENTE



VISTA LATERAL

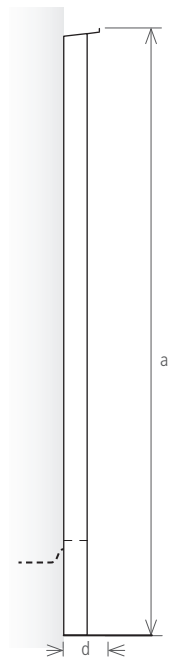

\*\* o segundo suporte só é aplicado no modelo MX1800

# M TUBE

SECA-TOALHAS

Dando continuidade à linha minimalista, e tendo como principal objetivo a criação de seca-toalhas para espaços reduzidos, a Foursteel apresenta o M Tube. Disponível em aço inox nos acabamentos: branco, forja, polido ou escovado.





MATERIAL aço inox

ACABAMENTOS



POLIDO



ESCOVADO



FORJA



BRANCO



COR RAL

ACABAMENTO EM TITÂNIO \*



OURO



OURO VELHO



COBRE

VISTA DE FRENTE

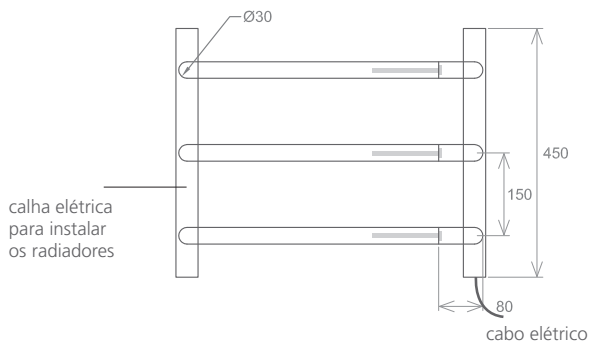

VISTA LATERAL

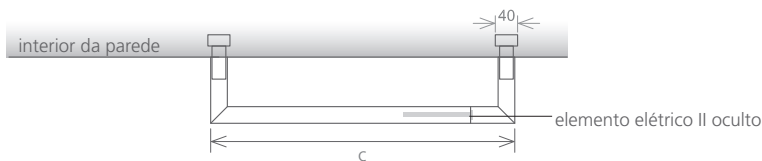
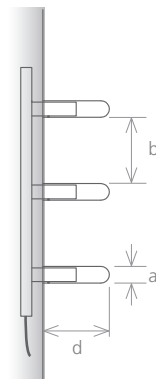

VISTA DE CIMA

ACESSÓRIOS



MIMOO  
SWITCH



DOMOTIC  
TOUCH

modelo	MT3 550	elem. adicional	MT3 800	elem. adicional
n° de elementos	3	1	3	1
altura dos elementos (mm) a	30	30	30	30
distância entre elementos (mm) b	120	-	120	-
largura total (mm) c	550	550	800	800
profundidade (mm) d	120	120	120	120
capacidade (l) elétrico (W)	3x0,4	0,4	3x0,6	0,6
	3x40	40	3x40	40

# M TUBE SQUARE

SECA-TOALHAS





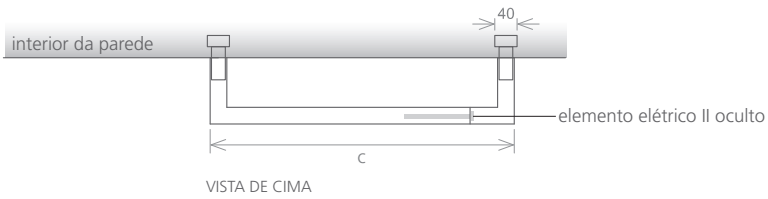
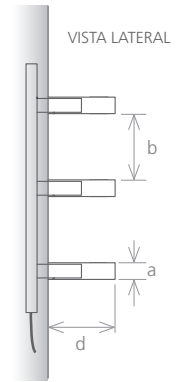
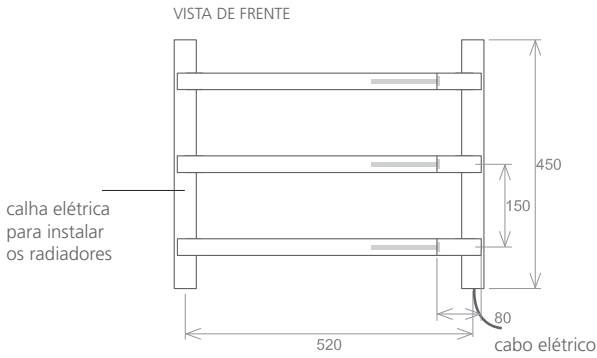



MATERIAL aço inox

ACABAMENTOS



POLIDO



ESCOVADO



FORJA



BRANCO



COR RAL

ACABAMENTO EM TITÂNIO \*



OURO



OURO VELHO



COBRE



## ACESSÓRIOS



MIMOO  
SWITCH



DOMOTIC  
TOUCH

modelo	MTS3 550	elem. adicional	MTS3 800	elem. adicional
n° de elementos	3	1	3	1
altura dos elementos (mm) a	30	30	30	30
distância entre elementos (mm) b	120	-	120	-
largura total (mm) c	550	550	800	800
profundidade (mm) d	120	120	120	120
capacidade (l)	3x0,4	0,4	3x0,6	0,6
elétrico (W)	3x40	40	3x40	40

# M TUBE ROUND

SECA-TOALHAS



MATERIAL aço inox

## ACABAMENTOS



POLIDO



ESCOVADO



FORJA



BRANCO



COR RAL

## ACABAMENTO EM TITÂNIO \*



OURO



OURO VELHO



COBRE

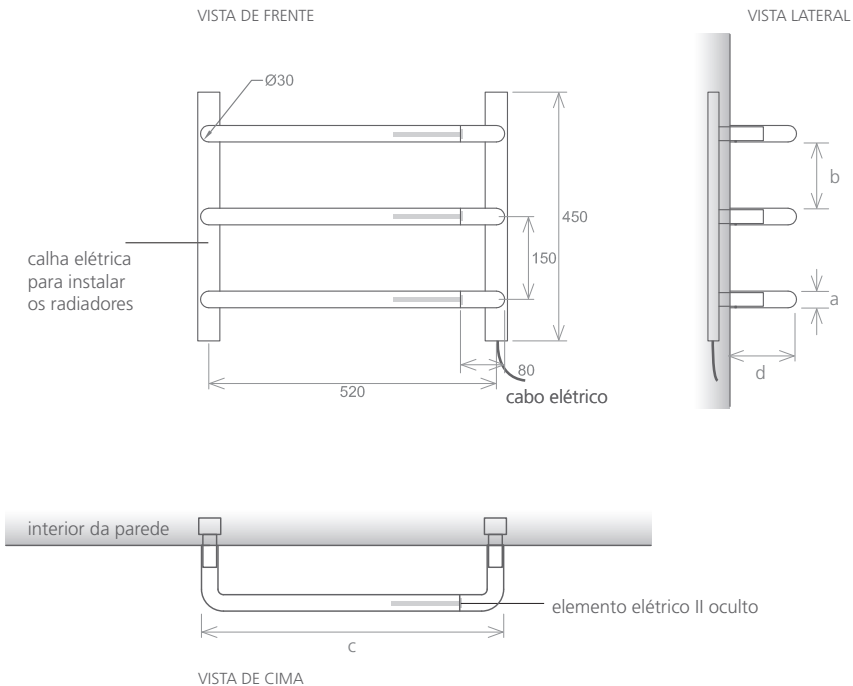

#### ACESSÓRIOS



MIMOO  
SWITCH



DOMOTIC  
TOUCH

modelo	MTR3 550	elem. adicional	MTR3 800	elem. adicional
n° de elementos	3	1	3	1
altura (mm) a	30	30	30	30
distância entre elementos (mm) b	120	-	120	-
largura total (mm) c	550	550	800	800
profundidade (mm) d	120	120	120	120
capacidade (l)	3x0,4	0,4	3x0,6	0,6
elétrico (W)	3x40	40	3x40	40

# M SLIM

SECA-TOALHAS

Toalheiro elétrico minimalista M Slim, disponível em aço inoxidável polido e escovado, cores ral e em acabamentos titânio (ouro e cobre).



# M SLIM

SECA-TOALHAS

vista de frente

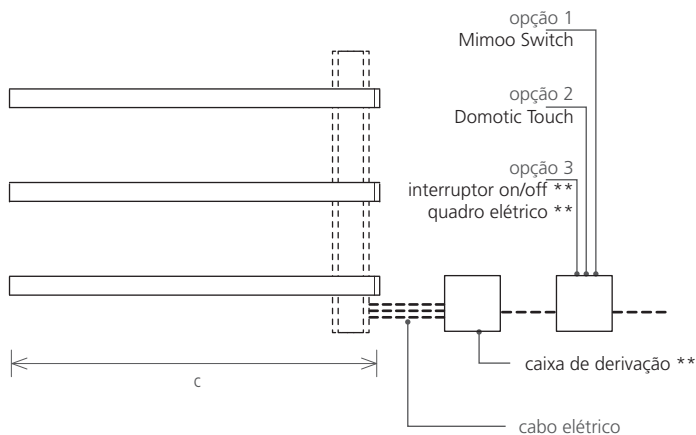

\*\* Produtos não fornecidos pela Foursteel.

MATERIAL aço inox

ACABAMENTOS



POLIDO



ESCOVADO



FORJA



BRANCO



COR RAL

ACABAMENTO EM TITÂNIO \*



OURO



OURO VELHO



COBRE



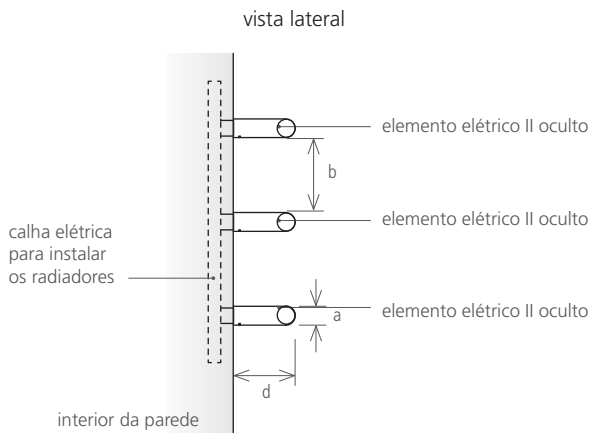

## ACESSÓRIOS



MIMOO  
SWITCH



DOMOTIC  
TOUCH

modelo	MS3 600	elem. adicional
nº de elementos	3	1
altura (mm) a	30	30
distância entre elementos (mm) b	120	-
largura total (mm) c	600	600
profundidade (mm) d	80	90
capacidade (l)	3x0,6	0,6
elétrico (W)	3x40	40

# M SLIM SQUARE

SECA-TOALHAS

Toalheiro elétrico minimalista M Slim, disponível em aço inoxidável polido e escovado, cores ral e em acabamentos titânio (ouro e cobre).



# M SLIM SQUARE

SECA-TOALHAS

vista de frente

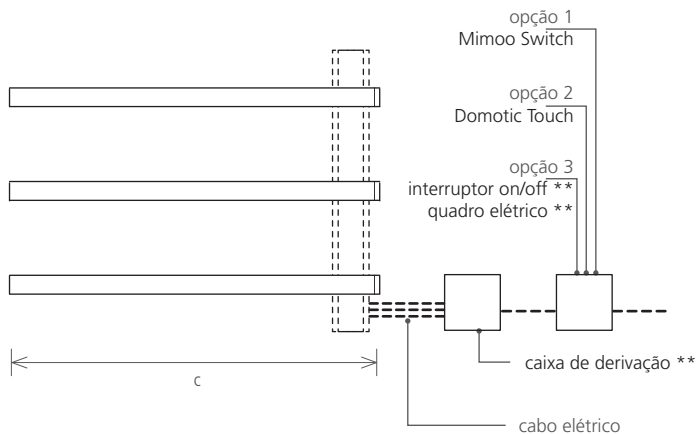

\*\* Produtos não fornecidos pela Foursteel.

MATERIAL aço inox

ACABAMENTOS



POLIDO



ESCOVADO



FORJA



BRANCO



COR RAL

ACABAMENTO EM TITÂNIO \*



OURO



OURO VELHO



COBRE

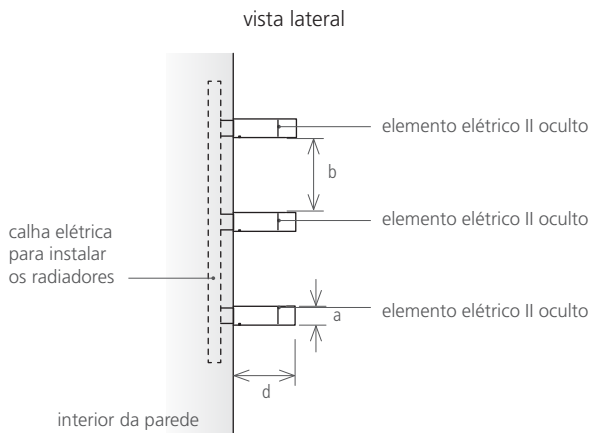

## ACESSÓRIOS



MIMOO  
SWITCH



DOMOTIC  
TOUCH

modelo	MSS3 600	elem. adicional
nº de elementos	3	1
altura (mm) a	30	30
distância entre elementos (mm) b	120	-
largura total (mm) c	600	600
profundidade (mm) d	80	80
capacidade (l)	3x0,6	0,6
elétrico (W)	3x40	40

# FOURSLIM BY ARCHITECTS

SECA-TOALHAS

Da expressão “less is more” surge o seca-toalhas Fourslim em parceria com o atelier Manuel Aires Mateus. O Fourslim é um seca-toalhas que poderá ser usado com dois, três ou mais elementos dentro do mesmo espaço. Para sistemas de aquecimento central, elétrico ou misto este radiador irá proporcionar um ambiente diferenciador.



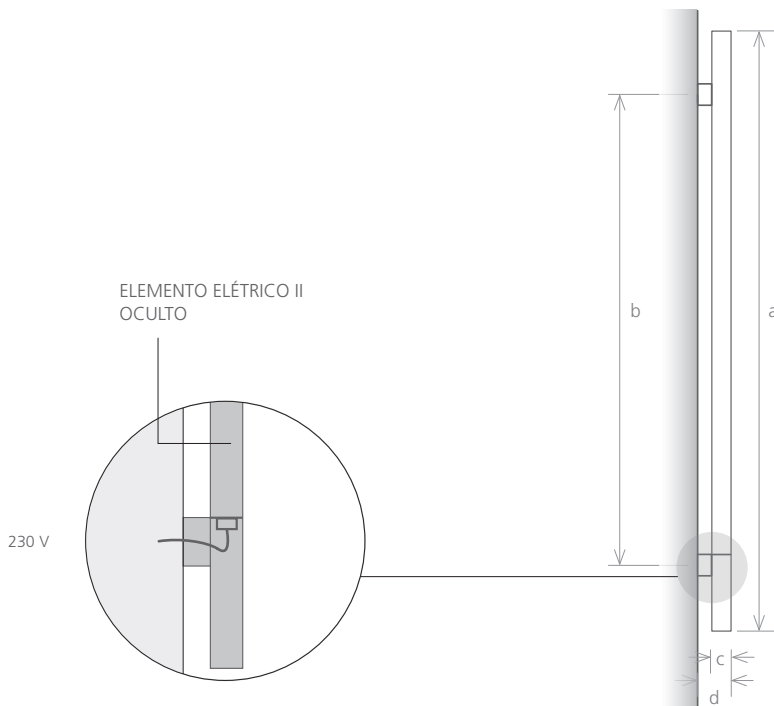

versão elétrica: na posição horizontal a profundidade é de 75mm

		elemento elétrico II oculto			versão misto - mural + elétrico II		
modelo		FS 800	FS 1200	FS 1400	FSM 800	FSM 1200	FSM 1400
altura (mm)	a	800	1200	1400	880	1280	1480
distância entre eixos (mm)	b	645	945	1145	620	1020	1220
largura total (mm)	c	35	35	35	42	42	42
profundidade (mm)	d	65	65	65	100	100	100
capacidade (l)		0,6	0,8	1,0	0,7	0,9	1,2
aquecimento central (W)		-	-	-	63	97	124
elétrico (W)		40	100	150	40	100	150



MATERIAL aço inox

ACABAMENTOS



POLIDO



ESCOVADO



FORJA



BRANCO



COR RAL

ACABAMENTO EM TITÂNIO \*



OURO



OURO VELHO



COBRE





VERSÃO ELÉTRICA  
COM ELEMENTO II OCULTO

(passagem de cabo elétrico)



domotic touch (opcional)

## ACESSÓRIOS



KIT MURAL



MIMOO  
SWITCH



DOMOTIC  
TOUCH

AQUECIMENTO CENTRAL  
solução 1

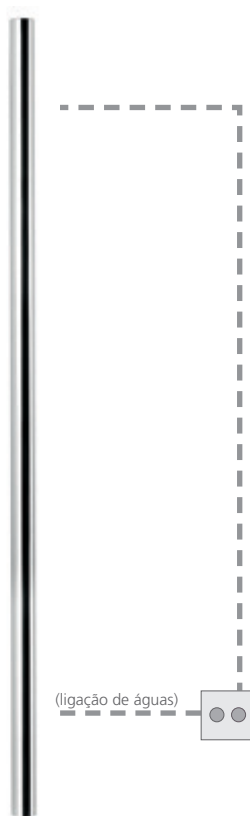

A ligação da entrada de águas é feita por um sistema de torneiras no exterior do produto.



## AQUECIMENTO CENTRAL

solução 2



Torneiras ocultas  
Ligação de águas

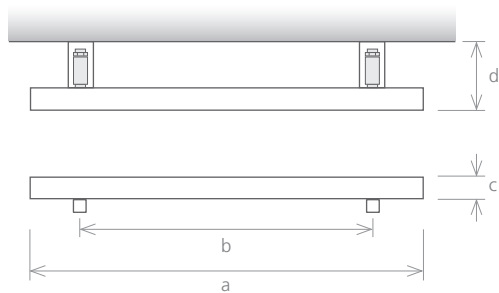

		aquec. central - sistema mural			aquec. central - torneiras		
modelo		FSA 800	FSA 1200	FSA 1400	FSA 800	FSA 1200	FSA 1400
altura	(mm) a	800	1200	1400	800	1200	1400
distância entre eixos	(mm) b	620	1020	1220	620	1020	1220
largura total	(mm) c	42	42	42	42	42	42
profundidade	(mm) d	100	100	100	130	130	130
capacidade	(l)	0,7	0,9	1,2	0,7	0,9	1,2
aquecimento central	(W)	63	97	124	63	97	124

# FOURSLIM ON/OFF

SECA-TOALHAS



Para maior conforto do utilizador foi introduzido um botão on/off no próprio seca-toalhas, para facilmente ligar e desligar.

VISTA INFERIOR

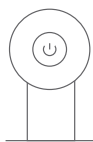

ELEMENTO ELÉTRICO II OCULTO

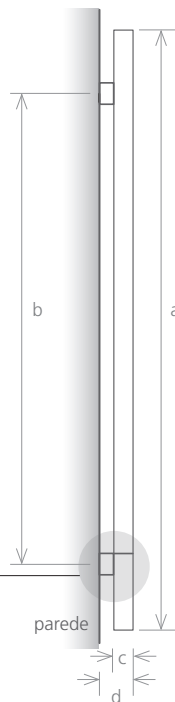
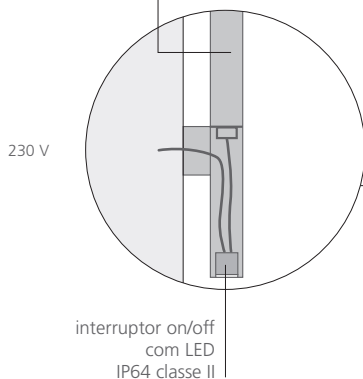

versão elétrica: na posição horizontal a profundidade é de 82mm

modelo	elem. elétrico II oculto - on/off			misto - sistema mural + on/off		
	FSO 800	FSO 1200	FSO 1400	FSOM 800	FSOM 1200	FSOM 1400
altura (mm) a	800	1200	1400	880	1280	1480
distância entre eixos (mm) b	645	945	1145	620	1020	1220
largura total (mm) c	42	42	42	42	42	42
profundidade (mm) d	72	72	72	100	100	100
capacidade (l)	0,6	0,8	1,0	0,7	0,9	1,2
aquecimento central (W)	-	-	-	63	97	124
elétrico (W)	40	100	150	40	100	150

# FOURSLIM SQUARE

SECA-TOALHAS

A linha do Fourslim emerge no perfil tubular quadrado, com a criação do Fourslim Square.

A versatilidade desta linha permite ao utilizador definir a sua orientação quer vertical ou horizontalmente.



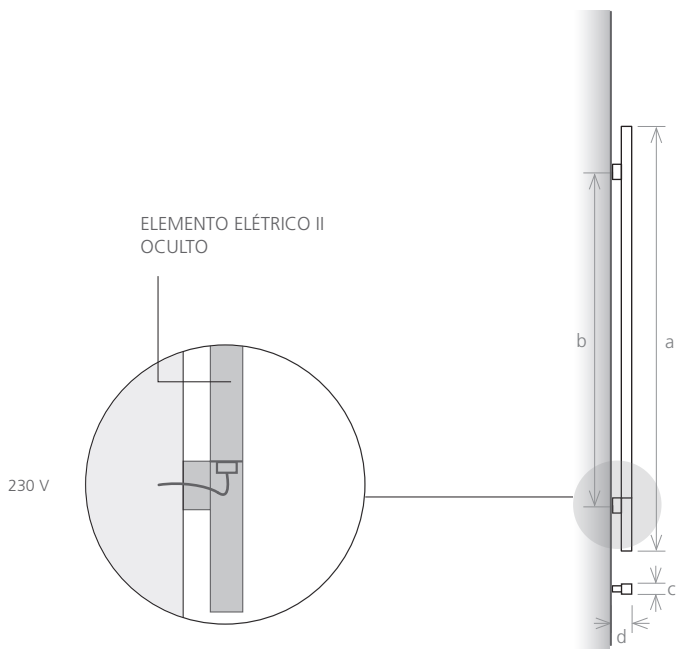

versão elétrica: na posição horizontal a profundidade é de 80mm

modelo	elemento elétrico II oculto			versão misto - mural + elétrico II		
	FSQ 800	FSQ 1200	FSQ 1400	FSQM 800	FSQM 1200	FSQM 1400
altura (mm) a	800	1200	1400	880	1280	1480
distância entre eixos (mm) b	645	945	1145	620	1020	1220
largura total (mm) c	40	40	40	40	40	40
profundidade (mm) d	70	70	70	98	98	98
capacidade (l)	0,6	0,8	1,0	0,7	0,9	1,2
aquecimento central (W)	-	-	-	63	97	124
elétrico (W)	40	100	150	40	100	150



MATERIAL aço inox

ACABAMENTOS



POLIDO



ESCOVADO



FORJA



BRANCO



COR RAL

ACABAMENTO EM TITÂNIO \*



OURO



OURO VELHO



COBRE





VERSÃO ELÉTRICA  
COM ELEMENTO II OCULTO

(passagem de cabo elétrico)



domotic touch (opcional)

## ACESSÓRIOS



KIT MURAL



MIMOO  
SWITCH



DOMOTIC  
TOUCH

AQUECIMENTO CENTRAL  
solução 1



A ligação da entrada de águas é feita por um sistema de torneiras no exterior do produto.





Torneiras ocultas  
Ligação de águas

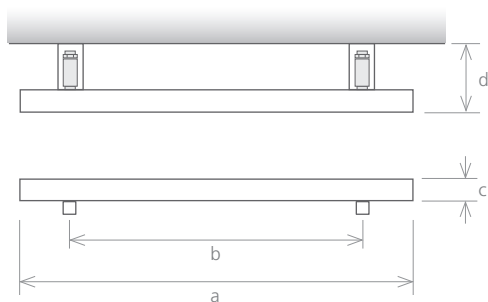

		aquec. central - sistema mural			aquec. central - torneiras		
modelo		FSQA 800	FSQA 1200	FSQA 1400	FSQA 800	FSQA 1200	FSQA 1400
altura (mm)	a	800	1200	1400	800	1200	1400
distância entre eixos (mm)	b	620	1020	1220	620	1020	1220
largura total (mm)	c	40	40	40	40	40	40
profundidade (mm)	d	98	98	98	128	128	128
capacidade (l)		0,7	0,9	1,2	0,7	0,9	1,2
aquecimento central (W)		63	97	124	63	97	124

# FOURSLIM SQUARE ON/OFF

SECA-TOALHAS



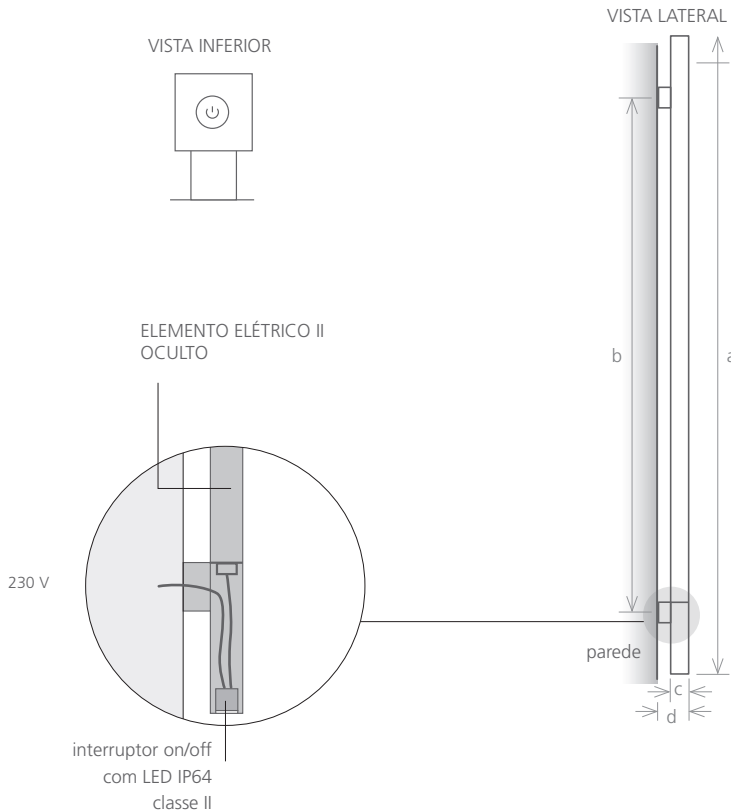

versão elétrica: na posição horizontal a profundidade é de 80mm

	elemento elétrico II oculto			versão misto - mural + elétrico II		
modelo	FSQO 800	FSQO 1200	FSQO 1400	FSQOM 800	FSQOM 1200	FSQOM 1400
altura (mm) a	800	1200	1400	880	1280	1480
distância entre eixos (mm) b	645	945	1145	620	1020	1220
largura total (mm) c	40	40	40	40	40	40
profundidade (mm) d	70	70	70	98	98	98
capacidade (l)	0,6	0,8	1,0	0,7	0,9	1,2
aquecimento central (W)	-	-	-	63	97	124
elétrico (W)	40	100	150	40	100	150



# FOURSLIM SQUARE LED

SECA-TOALHAS

O toalheiro elétrico Fourslim Square LED tem como função o aquecimento da toalha bem como permitir ter uma luz ambiente sutil e envolvente de baixo consumo energético.

Estas duas funções poderão ser utilizadas de forma alternada ou em simultâneo.



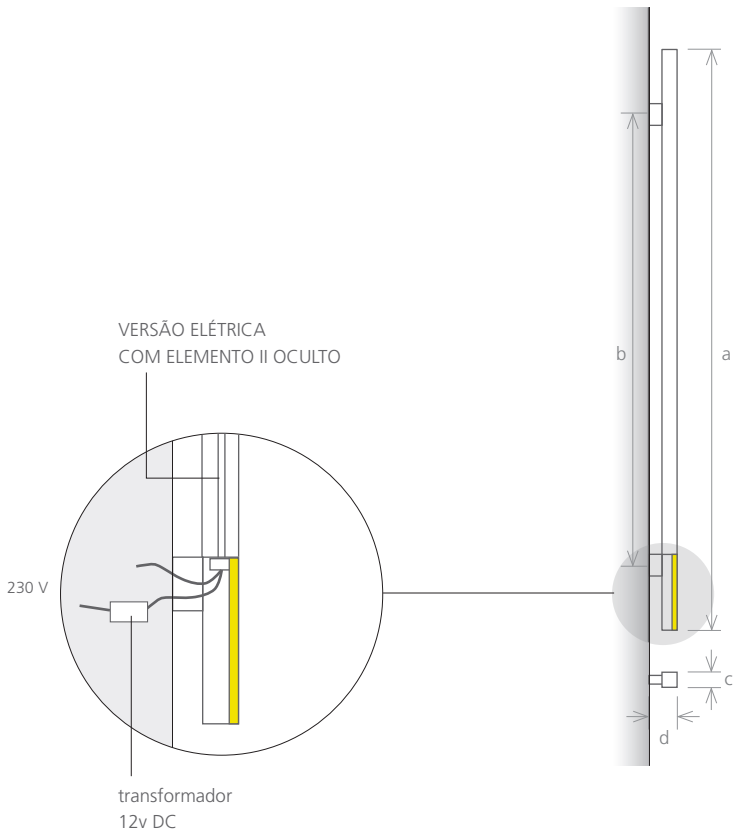

modelo	FSQL 800	FSQL 1200	FSQL 1400
altura (mm) a	800	1200	1400
distância entre eixos (mm) b	645	945	1145
largura total (mm) c	40	40	40
profundidade (mm) d	70	70	70
capacidade (l)	0,6	0,8	1,0
elétrico (W)	40	100	150

# SKINNY

SECA-TOALHAS

O seca-toalhas elétrico Skinny caracteriza-se pela sua essência minimalista.

A utilização de vários elementos permite a criação de uma composição livre que pode ser aplicada em qualquer tipo de espaço, fixo ao chão ou na versão móvel.

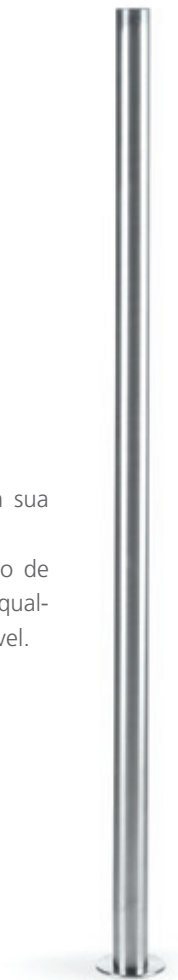



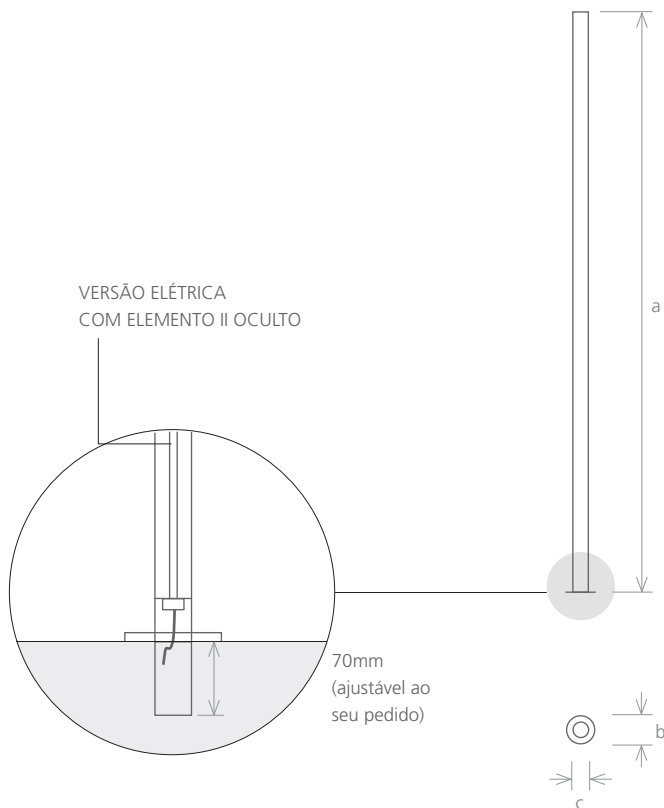

		fixo ao chão			móvel		
modelo		SK 900	SK 1200	SK 1400	SKM 900	SKM 1200	SKM 1400
altura (mm)	a	900	1200	1400	900	1200	1400
largura total (mm)	b	90	90	90	280	280	280
diâmetro do tubo (mm)	c	42	42	42	42	42	42
capacidade (l)		0,6	0,8	1,0	0,6	0,8	1,0
elétrico (W)		40	100	150	40	100	150

VERSÃO: MÓVEL



MATERIAL aço inox

ACABAMENTOS



POLIDO



ESCOVADO



FORJA



BRANCO



COR RAL

ACABAMENTO EM TITÂNIO \*



OURO



OURO VELHO



COBRE

VISTA DE FRENTE

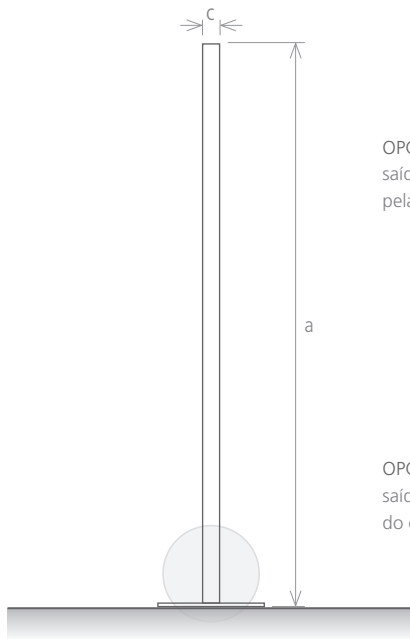

VISTA DE CIMA



OPÇÃO A  
saída do cabo elétrico  
pela parte inferior

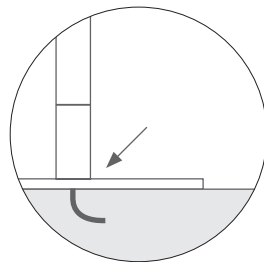

OPÇÃO B  
saída lateral  
do cabo elétrico

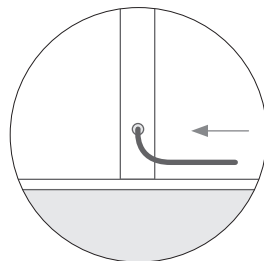

NOTA: Também disponível em versão "square".

## ACESSÓRIOS



MIMOO  
SWITCH



DOMOTIC  
TOUCH

**NOTA:**

**QUANDO NÃO IDENTIFICADO A POSIÇÃO DO ELEMENTO ELÉTRICO  
SERÁ SEMPRE COLOCADO DO LADO INFERIOR DIREITO**

**CORES RAL: cores sujeitas a confirmação.**

**BRANCO: RAL 9016 (RAL usado por definição)**

# THE EVOLUTION

design collection by architects

STEEL GLAM	62
STEEL ELEGANCE	74
FOURFOZ	78
STEEL WAVE	84
STEEL STONE	88

# STEEL GLAM

RADIADOR TOALHEIRO

ARQUITETO: GONÇALO BYRNE

De linhas direitas e perfil quadrado o Steel Glam surge como solução de aquecimento do espaço de banho. Foi assim dada resposta a necessidades de climatização e magnificência em termos estéticos para o edifício Estoril Sol Residence. A continuidade das linhas faz do Steel Glam uma aposta ganha pela Foursteel na conceção de equipamentos de design contemporâneo.





MATERIAL aço inox

ACABAMENTOS



POLIDO



ESCOVADO



FORJA



BRANCO



COR RAL

ACABAMENTO EM TITÂNIO \*



OURO



OURO VELHO



COBRE





---

ACESSÓRIOS



MIMOO  
SWITCH



DOMOTIC  
TOUCH

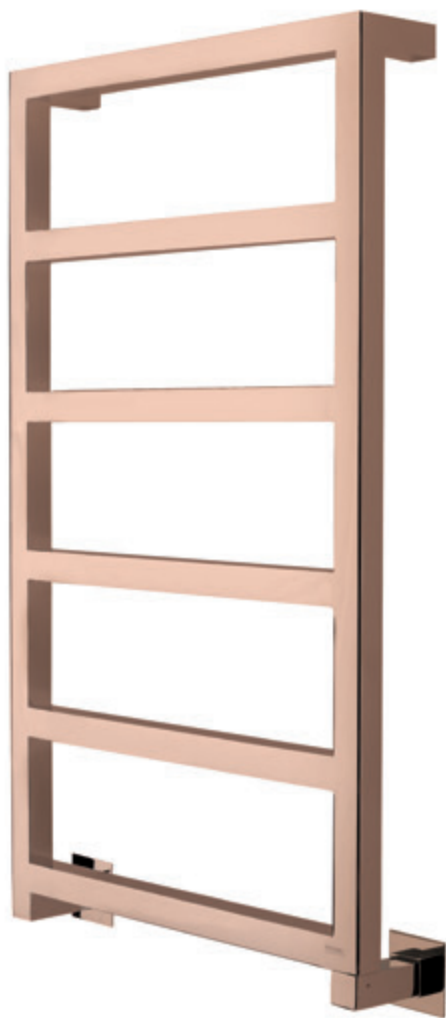



VERSÃO: AQUECIMENTO CENTRAL

VERSÃO: ELÉTRICO II OCULTO

VISTA DE FRENTE

VISTA LATERAL

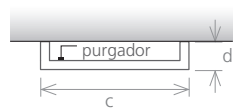
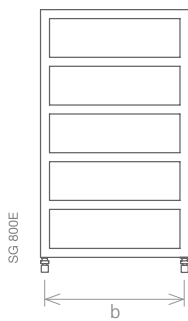

VISTA DE CIMA

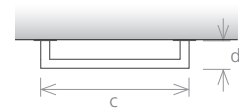
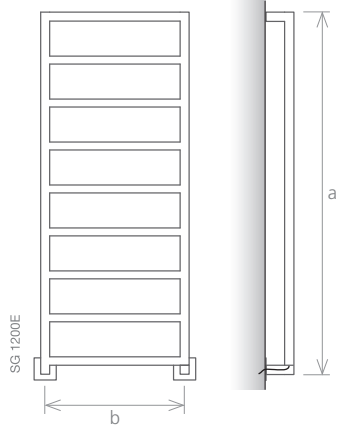



VERSÃO: ELÉTRICO IV

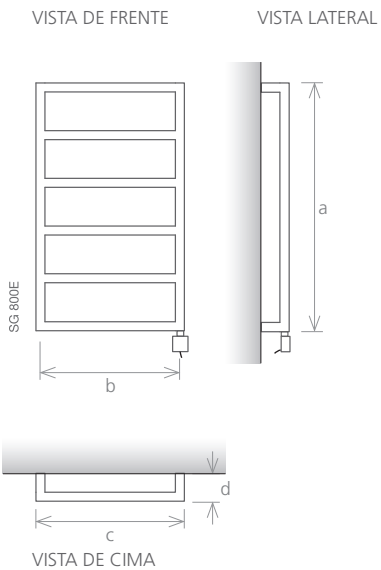

VERSÃO: MISTO COM ELEMENTO IV

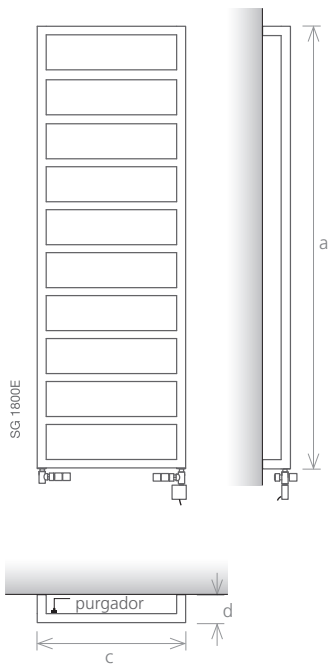





domotic touch (opcional)



versão elétrica com elemento II oculto





STEEL GLAM normal  
(SG)



STEEL GLAM esquina viva  
(SGS)

modelo		SG 800E	SG 800L	SG 1200E	SG 1200L	SG 1800E	SG 1800L
altura (mm)	a	800	800	1200	1200	1800	1800
distância entre eixos (mm)	b	450	500	450	500	450	500
largura total (mm)	c	480	530	480	530	480	530
profundidade (mm)	d	90	90	90	90	90	90
capacidade (l)		2,8	3,1	4,0	4,6	6,6	7,1
aquecimento central (W)		250	296	360	438	613	657
elétrico (W)		300	300	600	600	1000	1000

# STEEL ELEGANCE

## RADIADOR TOALHEIRO

Concebido num registo requintado, o Steel Elegance evoluiu de um *restyling* do Steel Classic [First Collection] para o projeto de remodelação do Hotel Savoy Madeira.

A redução das secções do material constituinte e a alteração do sistema de fixação depurou o conceito do radiador.

O resultado está à vista: um radiador toalheiro em aço inox com a simplicidade e excelência do clássico em plena harmonia com o conforto e leveza do presente.





MATERIAL aço inox

#### ACABAMENTOS



POLIDO



ESCOVADO

#### ACESSÓRIOS



MIMOO  
SWITCH



DOMOTIC  
TOUCH

VERSÃO: AQUECIMENTO CENTRAL

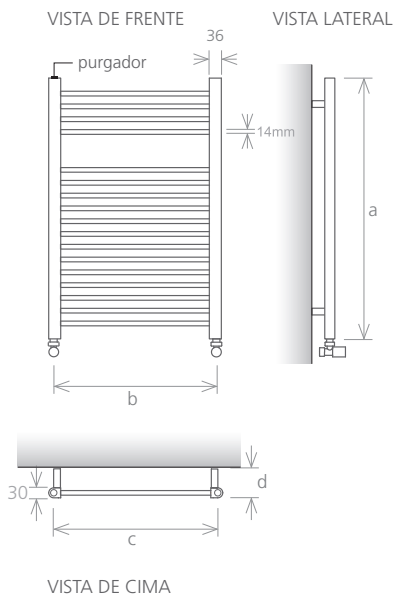

VERSÃO: ELÉTRICO V

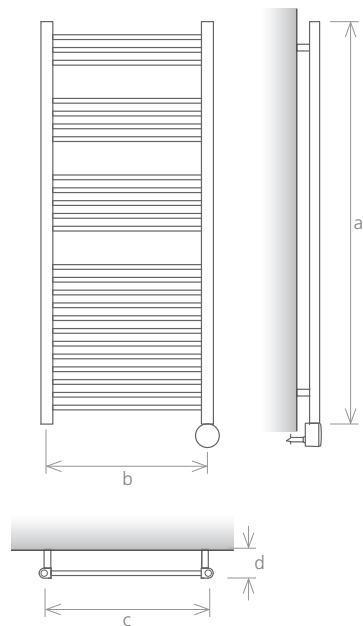

modelo		ELG 800E	ELG 800L	ELG 1200E	ELG 1200L	ELG 1800E	ELG 1800L
altura (mm)	a	800	800	1200	1200	1800	1800
distância entre eixos (mm)	b	450	500	450	500	450	500
largura total (mm)	c	480	530	480	530	480	530
profundidade (mm)	d	87	87	87	87	87	87
capacidade (l)		1,6	1,8	2,4	2,7	3,3	3,7
aquecimento central (W)		144	160	216	240	377	419
elétrico (W)		200	200	300	300	600	600

# FOURFOZ

RADIADOR TOALHEIRO

ARQUITETO: EDUARDO SOUTO DE MOURA

A liberdade do contorno e o respeito pela exigência funcional de secar toalhas ilustra a ousadia dos traços de mestre no desenho do radiador toalheiro Fourfoz, da autoria do Arq.<sup>to</sup> Eduardo Souto Moura.

Disponível em aço inox escovado ou aço inox polido, na versão de aquecimento central ou na versão elétrica, o Fourfoz atesta o rigor e o talento do reconhecido arquiteto.







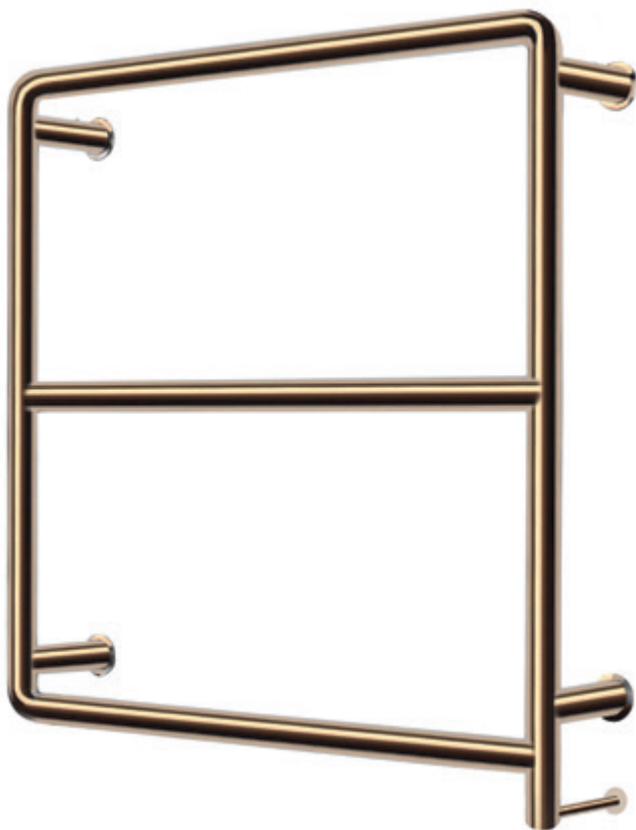

VISTA DE FRENTE

VISTA LATERAL

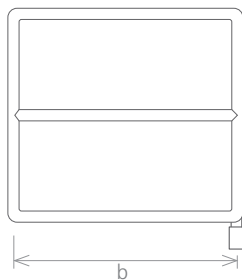
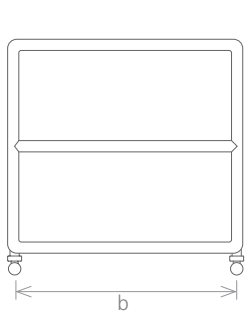

VISTA DE CIMA

MATERIAL aço inox

ACABAMENTOS



POLIDO



ESCOVADO

ACABAMENTO EM TITÂNIO\*



OURO



OURO VELHO



COBRE

ACESSÓRIOS



MIMO  
SWITCH



DOMOTIC  
TOUCH

VERSÃO: MISTO COM ELEMENTO II

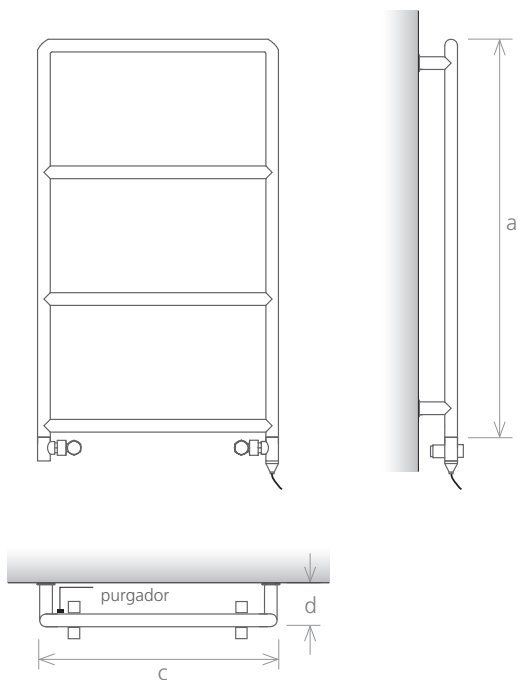

modelo	FF 525E	FF 525L	FF 800E	FF 800L
altura (mm) a	525	525	800	800
distância entre eixos (mm) b	450	500	450	500
largura total (mm) c	475	525	475	525
profundidade (mm) d	100	100	100	100
capacidade (l)	0,8	0,8	1,0	1,2
aquecimento central (W)	89	98	126	139
elétrico (W)	100	100	150	150

# STEEL WAVE

RADIADOR TOALHEIRO

Em combinação com a arquitetura do empreendimento Martinhal Beach Resort & Hotel em Sagres, o radiador toalheiro Steel Wave é uma resposta de simplicidade de estilo contemporâneo, desenvolvido sob a alçada do estúdio britânico de arquitetura e design Conran & Partners.





ormenor do elemento elétrico V

MATERIAL aço inox

#### ACABAMENTOS



POLIDO



ESCOVADO

#### ACESSÓRIOS



MIMOO  
SWITCH



DOMOTIC  
TOUCH

VERSÃO: AQUECIMENTO CENTRAL

VERSÃO: ELÉTRICO V

VERSÃO: MISTO COM ELEMENTO V

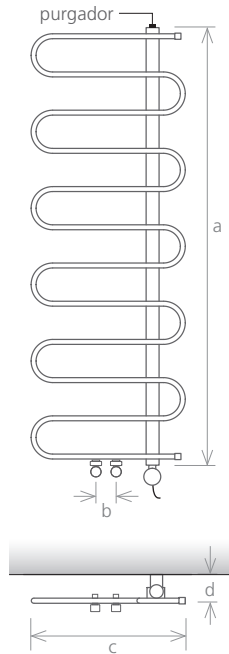
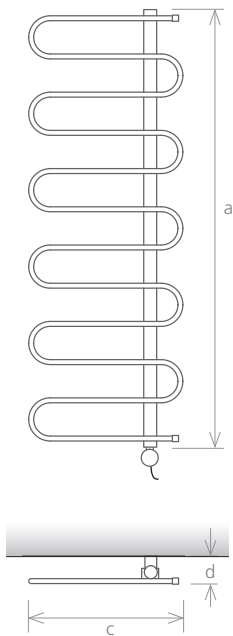
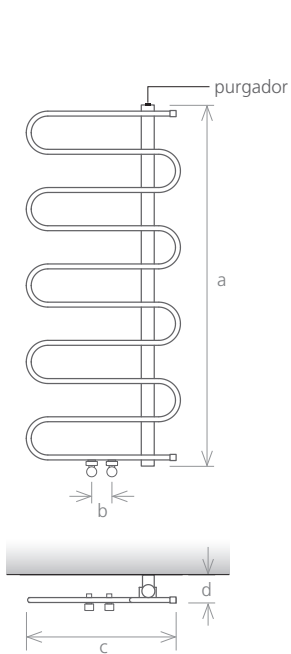

modelo		SW 800L	SW 800XL	SW 1200L	SW 1200XL	SW 1400L	SW 1400XL
altura (mm)	a	868	868	1100	1100	1332	1332
distância entre eixos (mm)	b	50	50	50	50	50	50
largura total (mm)	c	500	600	500	600	500	600
profundidade (mm)	d	90	90	90	90	90	90
capacidade (l)		3,1	3,5	4,0	4,6	6,1	6,9
aquecimento central (W)		279	317	360	438	545	616
elétrico (W)		200	200	300	300	600	600

# STEEL STONE

## RADIADOR TOALHEIRO

Radiador desenvolvido em parceria com o atelier de arquitetura José Carlos Cruz, com o intuito de criar um ambiente homogéneo e equilibrado num espaço de banho ou noutra divisão. Utilizando o mesmo revestimento das paredes\* como capa do radiador, pode ser aplicado em nichos (ficando à face da parede) ou no exterior da parede.

\* O material de revestimento deverá suportar temperaturas até 120° C.

Material aconselhado: pedras naturais, como mármore e granito.





versão elétrica com elemento II oculto

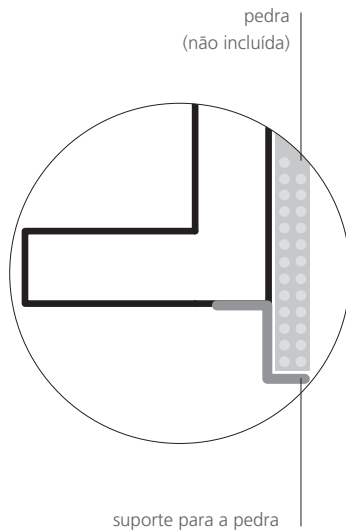

MATERIAL aço inox

#### ACABAMENTOS



POLIDO



ESCOVADO

#### ACESSÓRIOS



MIMOO  
SWITCH



DOMOTIC  
TOUCH

VERSÃO: AQUECIMENTO CENTRAL

VERSÃO: ELÉTRICO II

VISTA DE FRENTE

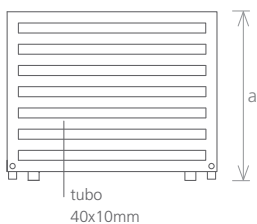

VISTA LATERAL

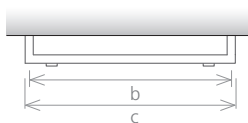
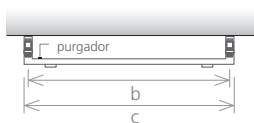
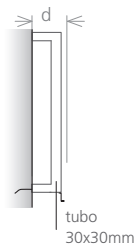
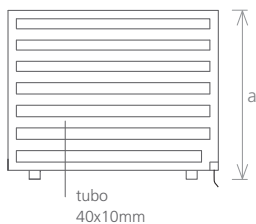
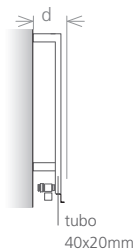

VISTA DE CIMA

modelo		SS 600 600	SS 400 900	SS 600 900	SS 400 1200	SS 600 1200	SS 800 1200
altura (mm)	a	600	400	600	400	600	800
distância entre eixos (mm)	b	560	860	860	1160	1160	1160
largura total (mm)	c	600	900	900	1200	1200	1200
profundidade (mm)	d	110	110	110	110	110	110
capacidade (l)		3,6	4,2	4,7	5,6	5,8	7,2
aquecimento central (W)		322	379	419	500	524	647
elétrico (W)		300	300	600	600	600	1000

**NOTA:**

**QUANDO NÃO IDENTIFICADO A POSIÇÃO DO ELEMENTO ELÉTRICO  
SERÁ SEMPRE COLOCADO DO LADO INFERIOR DIREITO**

**CORES RAL: cores sujeitas a confirmação.**

**BRANCO: RAL 9016 (RAL usado por definição)**

# FIRST COLLECTION

everyone is unique, every space in your home  
must be you, must be unique

STEEL CLASSIC 94

STEEL GLAMOUR 98

STEEL STYLE 102

# STEEL CLASSIC

RADIADOR TOALHEIRO

A excelência deste radiador toalheiro é conseguida pela ausência de soldaduras visíveis, a boa condutibilidade térmica e a sua durabilidade.

O Steel Classic, com traços delineados e requintados, é uma distinta proposta para a valorização do ambiente de banho.





MATERIAL aço inox

#### ACABAMENTOS



POLIDO



ESCOVADO

#### ACESSÓRIOS



MIMOO  
SWITCH



DOMOTIC  
TOUCH



VERSÃO: AQUECIMENTO CENTRAL

VERSÃO: ELÉTRICO V

VERSÃO: MISTO COM ELEMENTO II

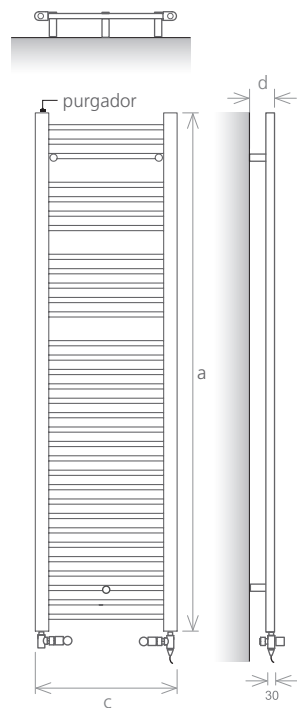
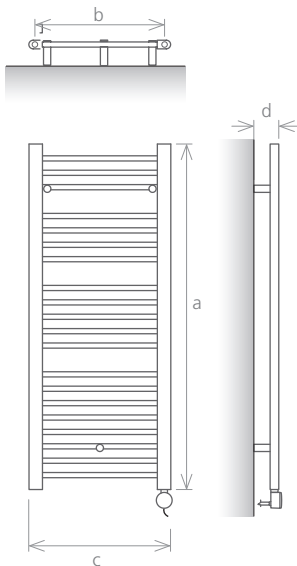
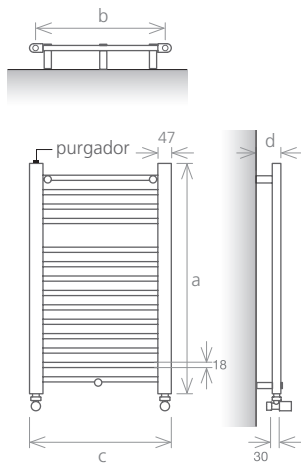

modelo		T 800E	T 800L	T 1200E	T 1200L	T 1800E	T 1800L
altura (mm)	a	800	800	1200	1200	1800	1800
distância entre eixos (mm)	b	450	500	450	500	450	500
largura total (mm)	c	492	542	492	542	492	542
profundidade (mm)	d	87	87	87	87	87	87
capacidade (l)		2,5	2,6	3,6	3,7	5,6	5,9
aquecimento central (W)		221	234	323	353	497	547
elétrico (W)		300	300	600	600	1000	1000

# STEEL GLAMOUR

RADIADOR TOALHEIRO

Steel Glamour é o reflexo das novas tendências no design, conjugando simplicidade, modernidade e elegância a um produto capaz de satisfazer os maiores níveis de exigência.



VERSÃO: AQUECIMENTO CENTRAL

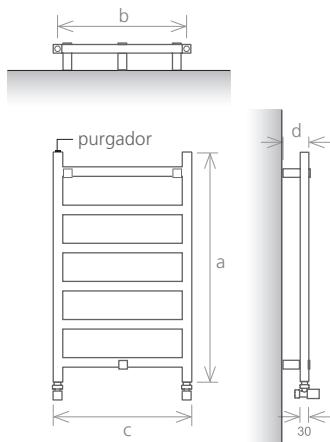

VERSÃO: ELÉTRICO II

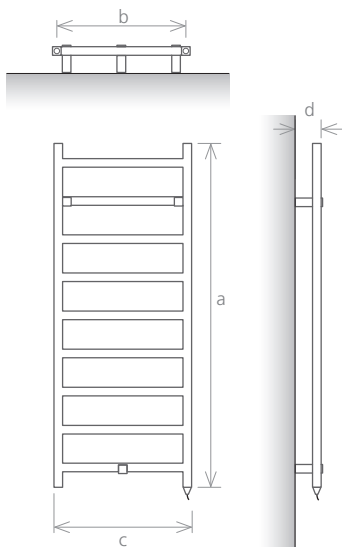

MATERIAL aço inox

ACABAMENTOS



POLIDO



ESCOVADO

ACABAMENTO EM TITÂNIO\*



OURO



OURO VELHO



COBRE

ACESSÓRIOS



MIMOO  
SWITCH



DOMOTIC  
TOUCH

VERSÃO: ELÉTRICO IV

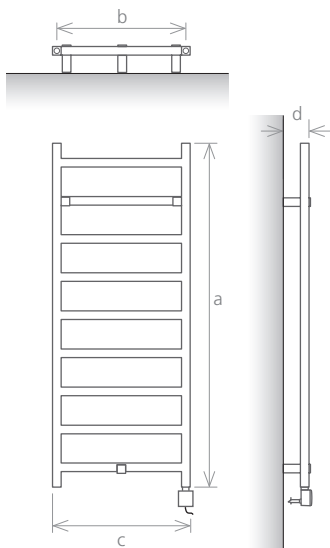

VERSÃO: MISTO COM ELEMENTO V

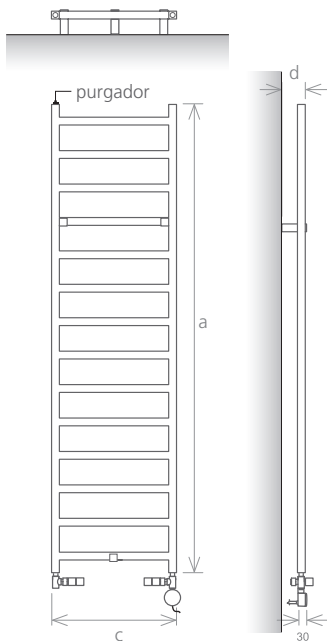

modelo		Q 800E	Q 800L	Q 1200E	Q 1200L	Q 1800E	Q 1800L
altura (mm)	a	800	800	1200	1200	1800	1800
distância entre eixos (mm)	b	450	500	450	500	450	500
largura total (mm)	c	480	530	480	530	480	530
profundidade (mm)	d	90	90	90	90	90	90
capacidade (l)		2,8	3,1	4,0	4,6	6,9	7,4
aquecimento central (W)		250	296	360	438	642	689
elétrico (W)		300	300	600	600	1000	1000

# STEEL STYLE

RADIADOR TOALHEIRO

A cor e a textura conferem um toque de modernidade à forma tradicional do radiador toalheiro Steel Style.

Para além do efeito decorativo, a sua versão elétrica permite que esta solução seja facilmente incorporada no ambiente de espaço de banho.





MATERIAL aço inox

ACABAMENTOS



FORJA



BRANCO

ACESSÓRIOS



MIMOO  
SWITCH



DOMOTIC  
TOUCH



VERSÃO: AQUECIMENTO CENTRAL

VERSÃO: ELÉTRICO V

VERSÃO: MISTO COM ELEMENTO II

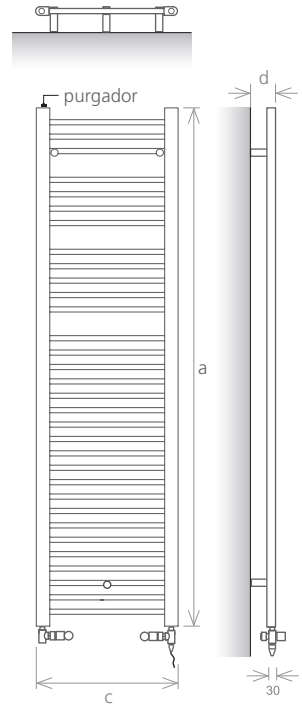
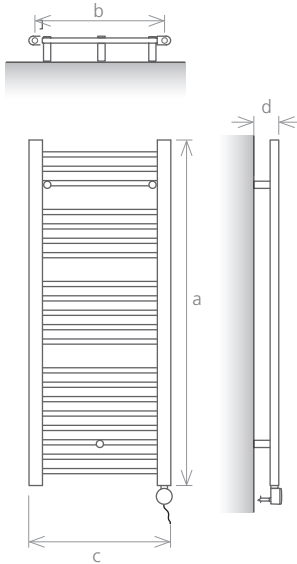
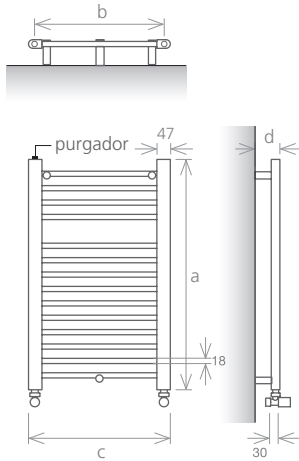

modelo		F 800E	F 800L	F 1200E	F 1200L	F 1800E	F 1800L
altura (mm)	a	800	800	1200	1200	1800	1800
distância entre eixos (mm)	b	450	500	450	500	450	500
largura total (mm)	c	492	542	492	542	492	542
profundidade (mm)	d	87	87	87	87	87	87
capacidade (l)		2,5	2,5	3,6	3,7	5,6	5,9
aquecimento central (W)		221	234	323	353	497	547
elétrico (W)		300	300	600	600	1000	1000

**NOTA:**

**QUANDO NÃO IDENTIFICADO A POSIÇÃO DO ELEMENTO ELÉTRICO  
SERÁ SEMPRE COLOCADO DO LADO INFERIOR DIREITO**

**CORES RAL: cores sujeitas a confirmação.**

**BRANCO: RAL 9016 (RAL usado por definição)**

## REWIND COLLECTION

...the perfect union between the old and the new...

EMPRESS	108
OLD BEAUTY	114
REMIND	120
FLOOR REMIND	124
RETRO SPECIAL	130
OLD GRACE	136
ROYALTY	140

# *Empress*

RADIADOR TOALHEIRO

A reinterpretação de elementos antigos numa linguagem atual esteve na origem do conceito do radiador toalheiro Empress.

Disponível em aço inox escovado, polido, dourado ou ouro velho, na versão de aquecimento central ou elétrica (elemento elétrico oculto).







## VERSÃO: AQUECIMENTO CENTRAL

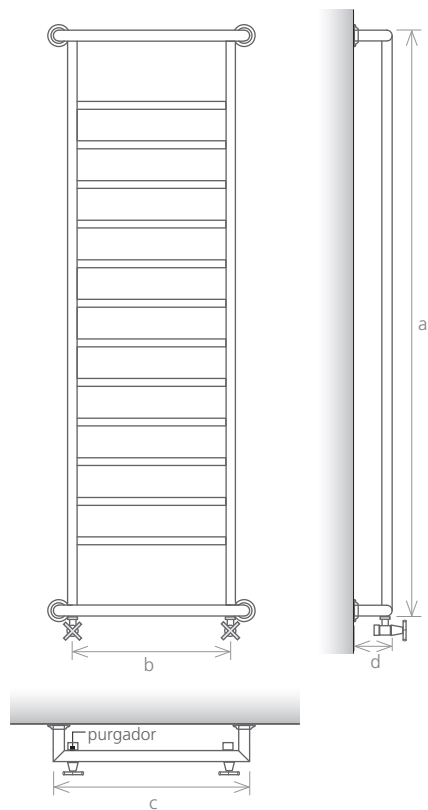

NOTA: Para os modelos superiores à altura de 800mm que contenham o elemento II, o 1º tubo do equipamento não aquece.

MATERIAL aço inox

### ACABAMENTOS



POLIDO

ESCOVADO

### ACABAMENTO EM TITÂNIO \*



OURO

OURO VELHO

COBRE

### ACESSÓRIOS



MIMOO  
SWITCH



DOMOTIC  
TOUCH



VERSÃO: ELÉTRICO II OCULTO

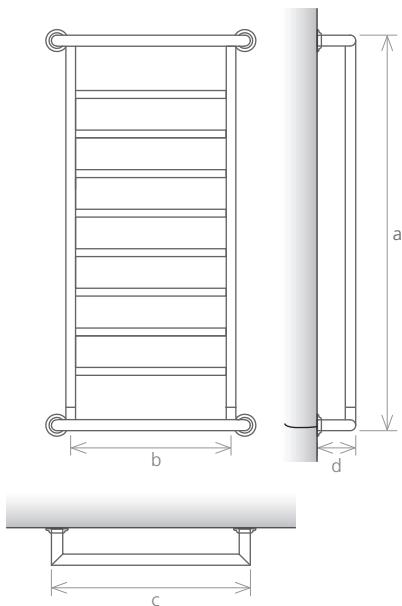

VERSÃO: MISTO

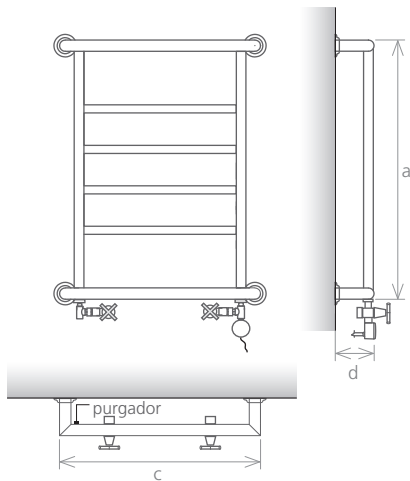

NOTA: Para os modelos superiores à altura de 800mm que contenham o elemento II, o 1º tubo do equipamento não aquece.

modelo		E 800E	E 800L	E 1200E	E 1200L	E 1800E	E 1800L
altura (mm)	a	800	800	1200	1200	1800	1800
distância entre eixos (mm)	b	450	500	450	500	450	500
largura total (mm)	c	570	620	570	620	570	620
profundidade (mm)	d	120	120	120	120	120	120
capacidade (l)		2,22	2,29	3,27	3,41	4,49	4,70
aquecimento central (W)		200	206	294	307	404	423
elétrico (W)		300	300	600	600	1000	1000

# *Old Beauty*

RADIADOR TOALHEIRO

Reinterpretar o clássico numa linguagem contemporânea foi o mote que esteve presente na conceção do radiador toalheiro Old Beauty.

Disponível em aço inox escovado, polido, dourado ou ouro velho, na versão de aquecimento central ou elétrica (elemento elétrico oculto).







VERSÃO: AQUECIMENTO CENTRAL

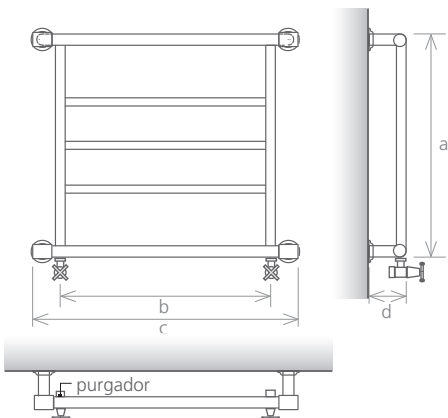

VERSÃO: ELÉTRICO II

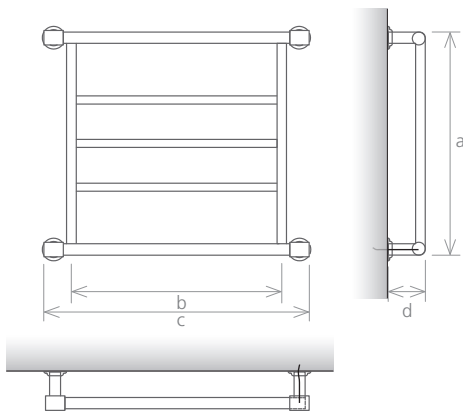

MATERIAL aço inox

ACABAMENTOS



POLIDO



ESCOVADO

ACABAMENTO EM TITÂNIO \*



OURO



OURO VELHO



COBRE

ACESSÓRIOS



MIMOO  
SWITCH



DOMOTIC  
TOUCH

VERSÃO: MISTO

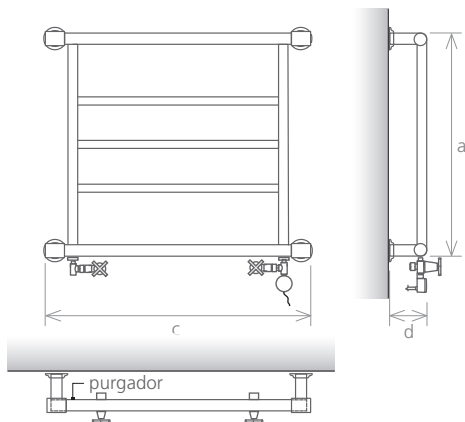

modelo		OB 800
altura (mm)	a	690
distância entre eixos (mm)	b	650 (variável)
largura total (mm)	c	820
profundidade (mm)	d	120
capacidade (l)		2,61
aquecimento central (W)		235
elétrico (W)		600

# *Remind*

## RADIADOR TOALHEIRO

Com carácter clássico e com o intuito de recuperar o vintage no seu estilo único, o radiador toalheiro Remind é uma fusão entre o antigo e o novo, o clássico e o irreverente.

Disponível em aço inox escovado, polido, dourado ou ouro velho, na versão de aquecimento central ou elétrica (elemento elétrico oculto).







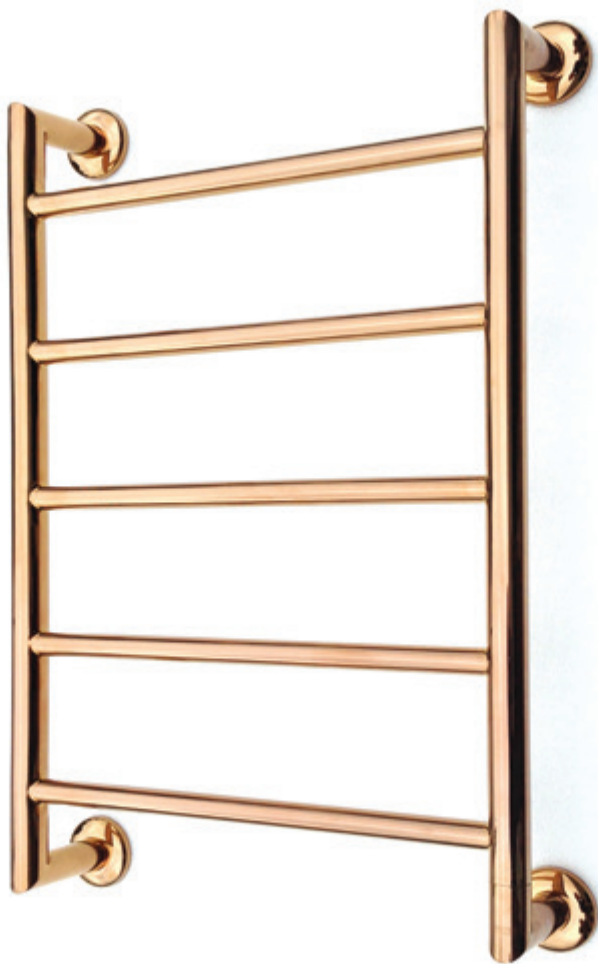

inox com acabamento ouro velho  
versão elétrica com elemento II oculto



MATERIAL aço inox

ACABAMENTOS



POLIDO



ESCOVADO

ACABAMENTO EM TITÂNIO \*



OURO



OURO VELHO



COBRE

ACESSÓRIOS



MIMOO  
SWITCH



DOMOTIC  
TOUCH

VERSÃO: AQUECIMENTO CENTRAL

VERSÃO: ELÉTRICO II OCULTO

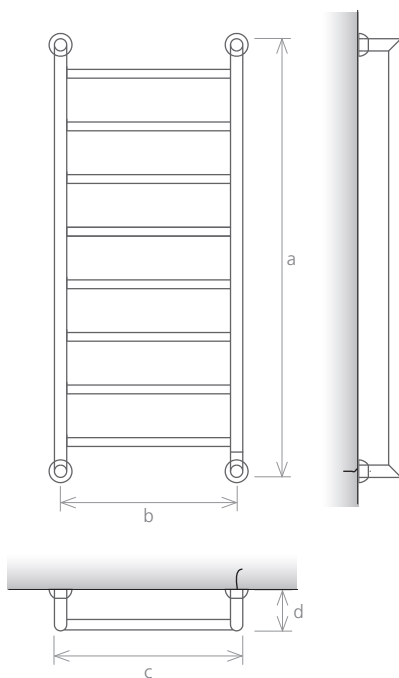
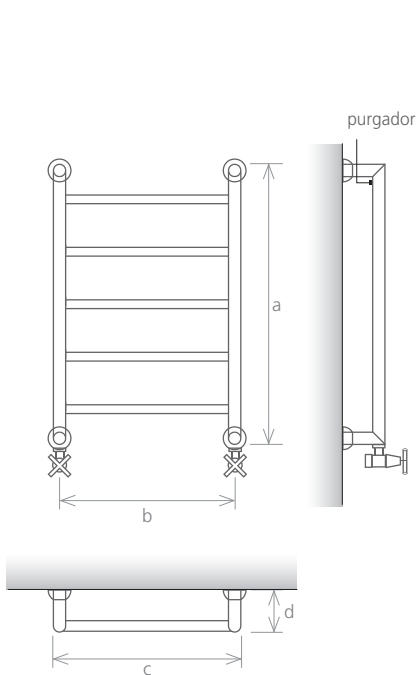

modelo	R 800E	R 800L	R 1200E	R 1200L	R 1800E	R 1800L
altura (mm) a	800	800	1250	1250	1850	1850
distância entre eixos (mm) b	450	500	450	500	450	500
largura total (mm) c	485	535	485	535	485	535
profundidade (mm) d	120	120	120	120	120	120
capacidade (l)	1,84	1,93	2,90	3,03	4,31	4,51
aquecimento central (W)	165	174	261	272	387	405
elétrico (W)	300	300	600	600	1000	1000

# *Floor Remind*

RADIADOR TOALHEIRO

Funcionalidade, conforto e elegância são as características associadas ao radiador toalheiro Floor Remind permitindo desta forma diversificar a sua colocação.

Disponível em aço inox escovado, polido, dourado ou ouro velho, na versão de aquecimento central ou elétrica (elemento elétrico oculto).



VERSÃO: AQUECIMENTO CENTRAL

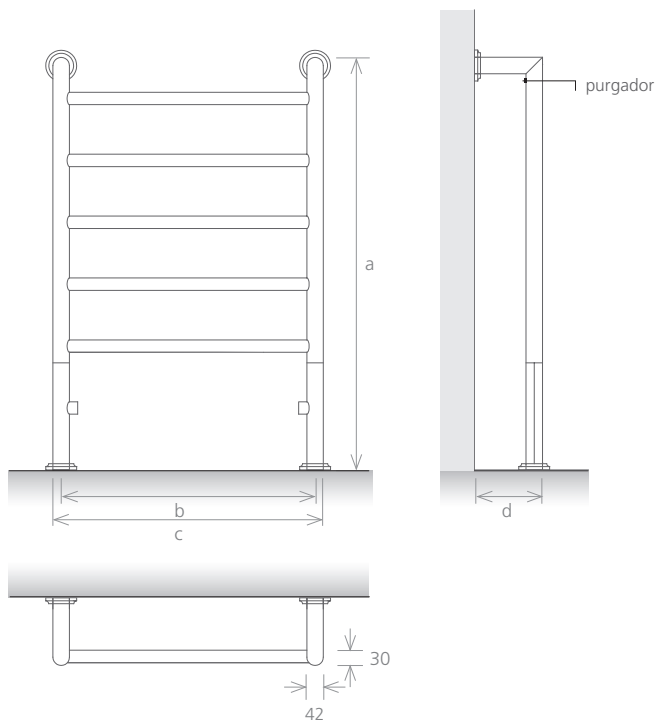

MATERIAL aço inox

ACABAMENTOS



POLIDO



ESCOVADO

ACABAMENTO EM TITÂNIO \*



OURO



OURO VELHO



COBRE

ACESSÓRIOS



MIMOO  
SWITCH



DOMOTIC  
TOUCH



VERSÃO: ELÉTRICO II OCULTO

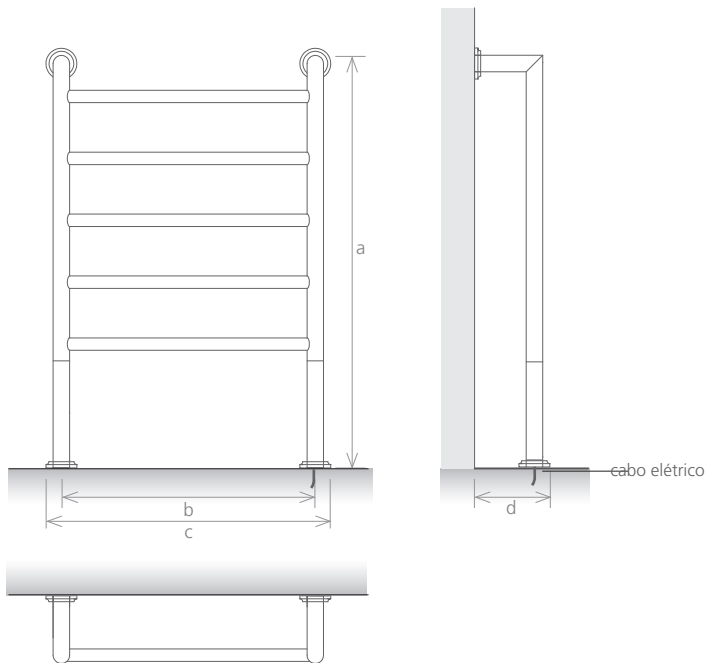

modelo		FR 1000	FR 1200	FR 1400
altura (mm)	a	1000	1200	1400
distância entre eixos (mm)	b	600	600	600
largura total (mm)	c	642	642	642
profundidade (mm)	d	140	140	140
capacidade (l)		3,69	4,26	5,17
aquecimento central (W)		332	398	465
elétrico (W)		600	600	1000

# *Retro Special*

RADIADOR TOALHEIRO





versão elétrica com elemento II oculto

MATERIAL aço inox / aço carbono

#### ACABAMENTOS



POLIDO



ESCOVADO



FORJA



BRANCO

#### ACABAMENTO EM TITÂNIO \*



OURO



OURO VELHO



COBRE

VERSÃO: ELÉTRICO IV OU V

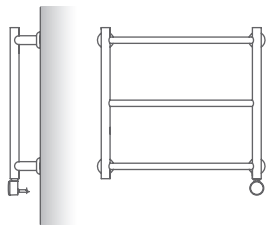

VERSÃO: ELÉTRICO IV OU V

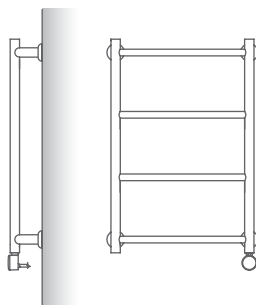

VERSÃO: ELÉTRICO II

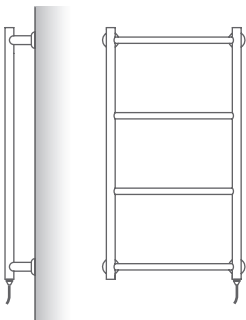

VERSÃO: ELÉTRICO IV OU V

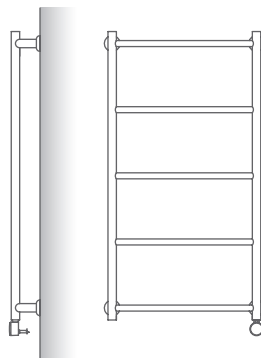

---

## ACESSÓRIOS



MIMOO  
SWITCH



DOMOTIC  
TOUCH

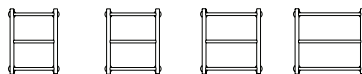

modelo	RE600 400	RE600 450	RE600 500	RE600 600
altura (mm)	600	600	600	600
distância entre eixos (mm)	400	450	500	600
largura total (mm)	435	485	535	635
profundidade (mm)	90	90	90	90
capacidade (l)	1,35	1,41	1,47	1,58
aquecimento central (W)	101	106	111	122
elétrico (W)	150	150	150	200

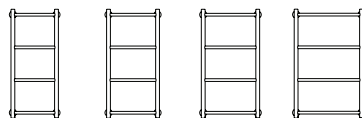

modelo	RE1000400	RE1000450	RE1000500	RE1000600
altura (mm)	1000	1000	1000	1000
distância entre eixos (mm)	400	450	500	600
largura total (mm)	435	485	535	635
profundidade (mm)	90	90	90	90
capacidade (l)	2,12	2,2	2,28	2,43
aquecimento central (W)	154	161	168	182
elétrico (W)	300	300	300	300

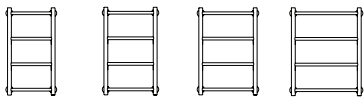

RE800 400	RE800 450	RE800 500	RE800 600	modelo
800	800	800	800	(mm) altura
400	450	500	600	(mm) distância entre eixos
435	485	535	635	(mm) largura total
90	90	90	90	(mm) profundidade
1,67	1,73	1,79	1,9	(l) capacidade
120	126	131	142	(W) aquecimento central
200	200	200	200	(W) elétrico

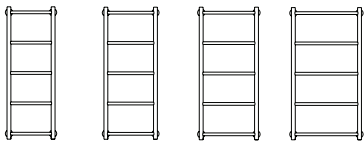

RE1200400	RE1200450	RE1200500	RE1200600	modelo
1200	1200	1200	1200	(mm) altura
400	450	500	600	(mm) distância entre eixos
435	485	535	635	(mm) largura total
90	90	90	90	(mm) profundidade
2,45	2,52	2,6	2,75	(l) capacidade
174	181	188	202	(W) aquecimento central
300	300	300	300	(W) elétrico

# *Old Grace*

RADIADOR TOALHEIRO

Numa reinterpretação de vários estilos do passado surge o radiador toalheiro Old Grace. A sua diferenciação reflete-se na superfície espelhada.

Disponível em aço inox escovado ou aço inox polido, na versão de aquecimento central ou elétrica.





VERSÃO: AQUECIMENTO CENTRAL

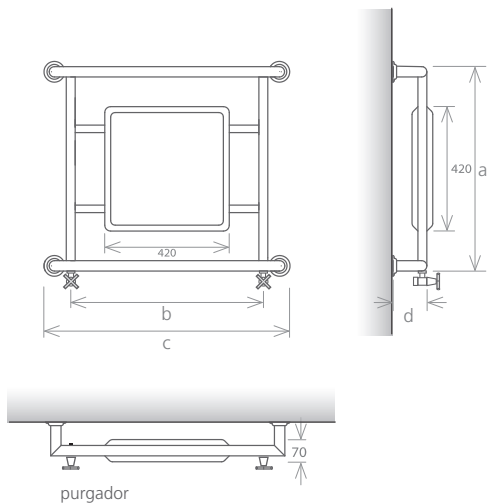

MATERIAL aço inox

ACABAMENTOS



POLIDO

ESCOVADO

ACABAMENTO EM TITÂNIO \*



OURO

OURO VELHO

COBRE

ACESSÓRIOS



MIMOO  
SWITCH



DOMOTIC  
TOUCH

VERSÃO: ELÉTRICO II (OCULTO)

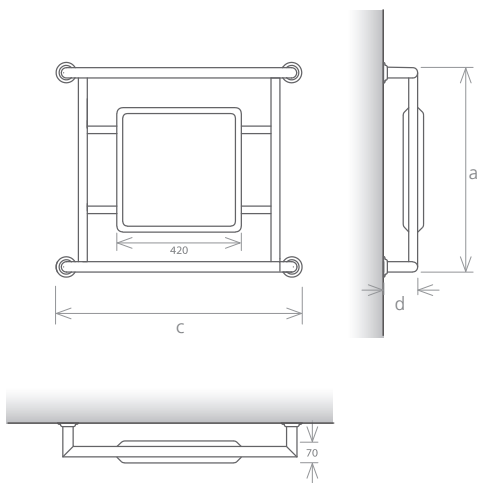

VERSÃO: MISTO

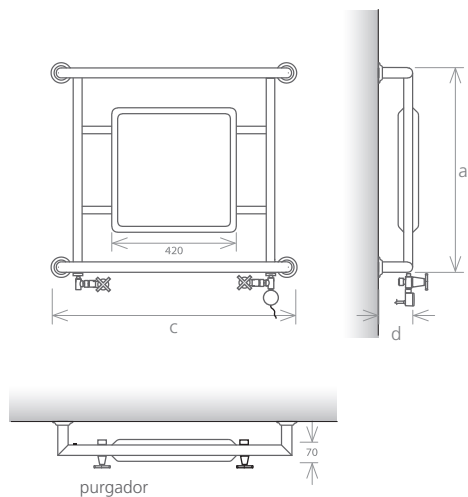

modelo		OG 800
altura (mm)	a	690
distância entre eixos (mm)	b	650
largura total (mm)	c	850
profundidade (mm)	d	120
capacidade (l)		2,40
aquecimento central (W)		390
elétrico (W)		600

# *Royalty*

RADIADOR

As linhas arrojadas e criativas refletem a vivacidade e originalidade do radiador de chão Royalty. Disponível na versão de aquecimento central ou na versão elétrica.



VERSÃO: AQUECIMENTO CENTRAL

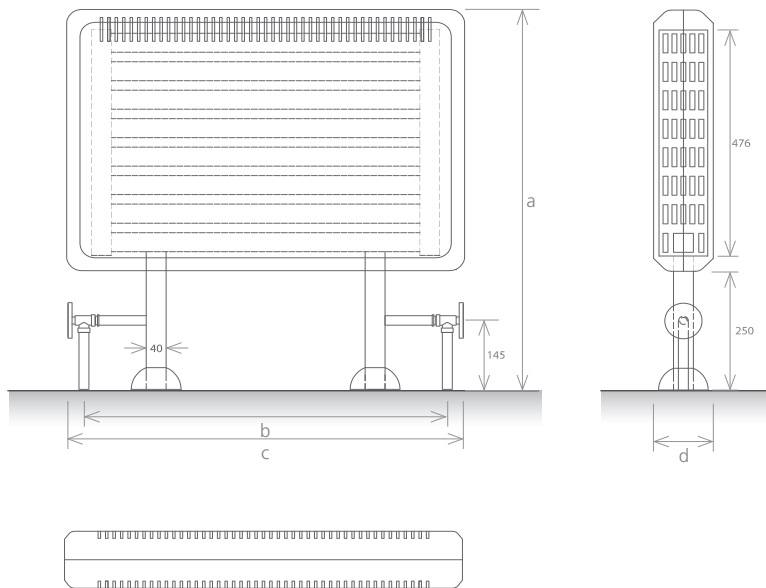

MATERIAL aço inox / aço carbono

ACABAMENTOS



POLIDO



ESCOVADO



FORJA



BRANCO

ACABAMENTO EM TITÂNIO \*



OURO



OURO VELHO



COBRE



versão de aquecimento central

#### ACESSÓRIOS



MIMOO  
SWITCH



DOMOTIC  
TOUCH

modelo		RO 800
altura (mm)	a	800
distância entre eixos (mm)	b	730
largura total (mm)	c	800
profundidade (mm)	d	120
capacidade (l)		14,2
aquecimento central (W)		2188
elétrico (W)		2000

**NOTA:**

**QUANDO NÃO IDENTIFICADO A POSIÇÃO DO ELEMENTO ELÉTRICO  
SERÁ SEMPRE COLOCADO DO LADO INFERIOR DIREITO**

**CORES RAL: cores sujeitas a confirmação.**

**BRANCO: RAL 9016 (RAL usado por definição)**



# NEW COLLECTION

moments of pure comfort for your bathroom

NEW SLIM	146
NEW SQUARE	150
NEW Q	154

# NEW SLIM

RADIADOR TOALHEIRO

O New Slim destaca-se pela elegância, sobriedade e requinte das suas formas. Uma solução simples para a criação de ambientes tranquilos e confortáveis no seu espaço de banho.

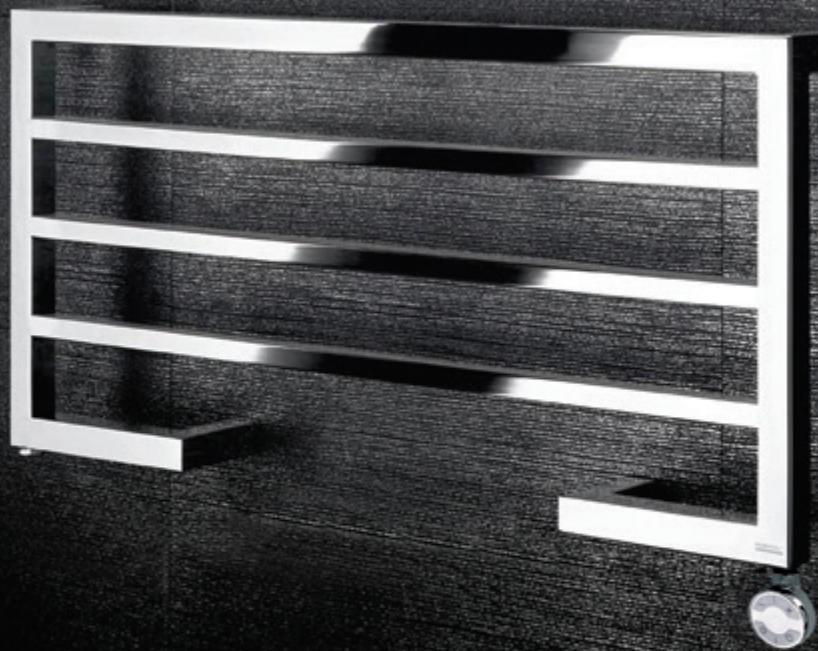

VERSÃO: AQUECIMENTO CENTRAL

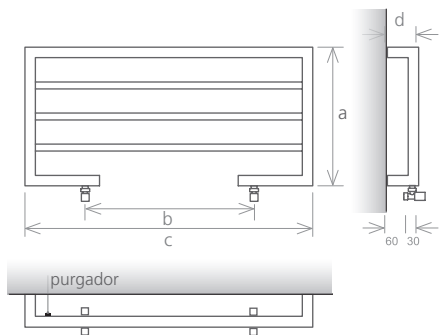

VERSÃO: ELÉTRICO IV OU V

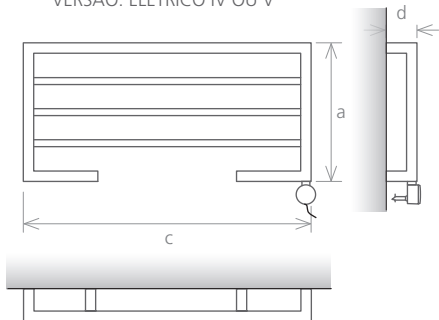

VERSÃO: MISTO

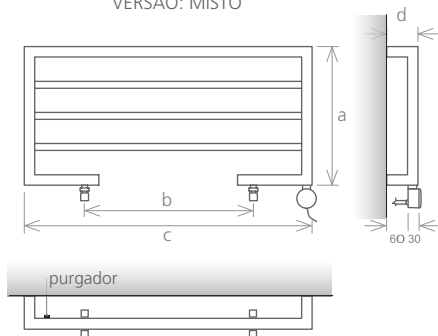

MATERIAL aço inox / aço carbono

ACABAMENTOS



ACESSÓRIOS





versão de aquecimento central

modelo	aquecimento central		elétrico
	NS 400 E	NS 400 L	NS 400
altura (mm) a	400	400	400
distância entre eixos (mm) b	450	500	-
largura total (mm) c	830	830	830
profundidade (mm) d	90	90	90
capacidade (l)	2,1	2,1	2,1
aquecimento central (W)	242	242	-
elétrico (W)	-	-	200

# NEW SQUARE

RADIADOR TOALHEIRO

New Square é um novo conceito de radiador toalheiro onde foram incorporadas prateleiras em Corian® para maior funcionalidade e conforto no seu espaço de banho.

De linhas direitas, elegante e sóbrio, o radiador toalheiro New Square está disponível na versão elétrica ou de aquecimento central.



## VERSÃO: AQUECIMENTO CENTRAL

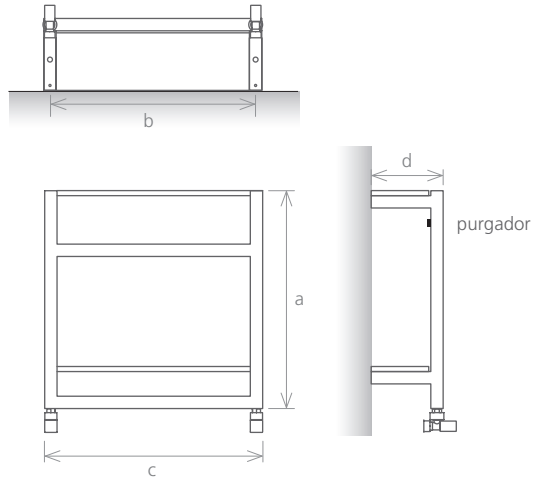

MATERIAL aço inox / aço carbono

### ACABAMENTOS



POLIDO



ESCOVADO



FORJA



BRANCO



COR RAL

### ACESSÓRIOS



MIMOO  
SWITCH



DOMOTIC  
TOUCH



VERSÃO: ELÉTRICO II

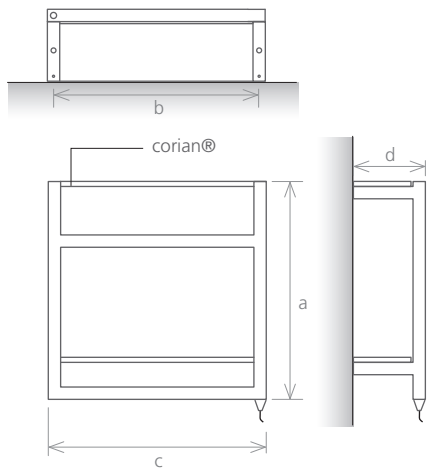

VERSÃO: ELÉTRICO V

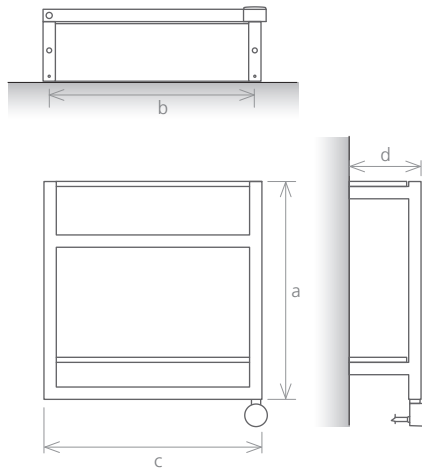

		aquecimento central		elétrico
modelo		NSQ 530E	NSQ 530L	NSQ 530
altura	(mm) a	530	530	530
distância entre eixos	(mm) b	450	500	-
largura total	(mm) c	530	530	530
profundidade	(mm) d	175	175	175
capacidade	(l)	1,1	1,1	1,1
aquecimento central	(W)	98	98	-
elétrico	(W)	-	-	200

# NEW Q

RADIADOR TOALHEIRO

Design, cor e funcionalidade são a combinação perfeita que deu origem ao radiador toalheiro New Q.

É um radiador flexível, que apresenta um design com detalhes e efeitos matizados em tons fortes.





MATERIAL aço inox / aço carbono

#### ACABAMENTOS



POLIDO



ESCOVADO



FORJA



BRANCO



COR RAL

#### ACESSÓRIOS



MIMOO  
SWITCH



DOMOTIC  
TOUCH

VERSÃO: AQUECIMENTO CENTRAL

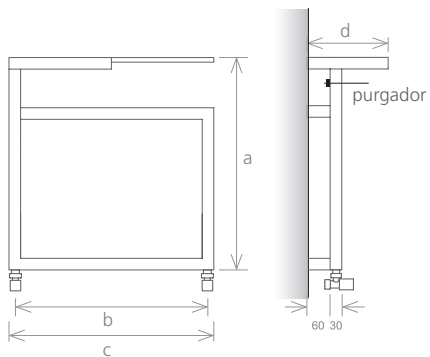

VERSÃO: ELÉTRICO II

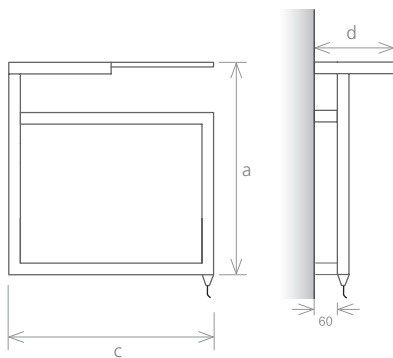

VERSÃO: ELÉTRICO IV OU V

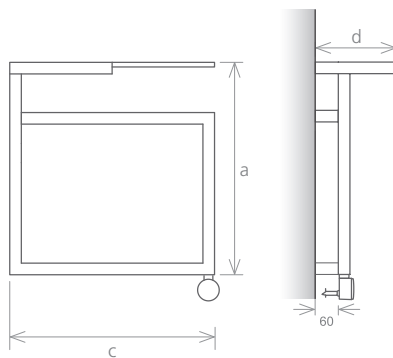

		aquecimento central		elétrico
modelo		NQ 550E	NQ 550L	NQ 550
altura (mm)	a	550	550	550
distância entre eixos (mm)	b	450	500	-
largura total (mm)	c	530	530	530
profundidade (mm)	d	210	210	210
capacidade (l)		0,4	0,4	0,4
aquecimento central (W)		36	36	-
elétrico (W)		-	-	200

**NOTA:**

**QUANDO NÃO IDENTIFICADO A POSIÇÃO DO ELEMENTO ELÉTRICO  
SERÁ SEMPRE COLOCADO DO LADO INFERIOR DIREITO**

**CORES RAL: cores sujeitas a confirmação.**

**BRANCO: RAL 9016 (RAL usado por definição)**

# BASIC LINE

the simple line

BASIC LINE 160

# BASIC LINE

RADIADOR TOALHEIRO

Basic Line é um radiador toalheiro prático, simples e uma solução económica para as necessidades de aquecimento das toalhas e espaço de banho. Em aço inox ou aço carbono, o Basic Line está disponível na versão elétrica, aquecimento central e versão mista.







MATERIAL aço inox / aço carbono

#### ACABAMENTOS



POLIDO



ESCOVADO



FORJA



BRANCO



COR RAL

#### ACESSÓRIOS



MIMOO  
SWITCH



DOMOTIC  
TOUCH



VERSÃO: AQUECIMENTO CENTRAL

VERSÃO: ELÉTRICO II

VERSÃO: ELÉTRICO III

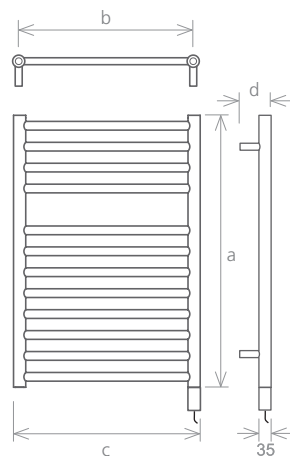
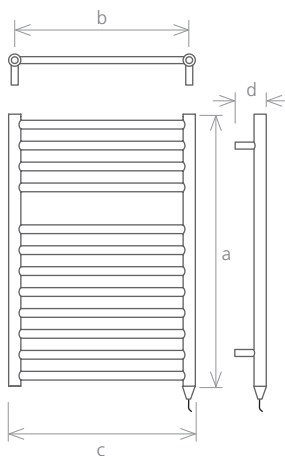
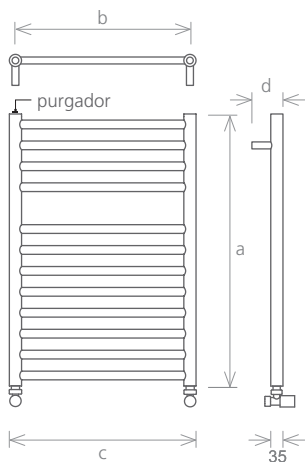

modelo		BL800E	BL800L	BL800XL	BL1200E	BL1200L	BL1200XL
altura (mm)	a	780	780	780	1200	1200	1200
distância entre eixos (mm)	b	450	500	600	450	500	600
largura total (mm)	c	485	535	635	485	535	635
profundidade (mm)	d	90	90	90	90	90	90
capacidade (l)		2,90	3,16	3,68	4,19	4,56	5,29
aquecimento central (W)		259,1	282,2	328,5	374,4	407,1	472,7
elétrico (W)		300	300	300	600	600	600

VERSÃO: MISTO

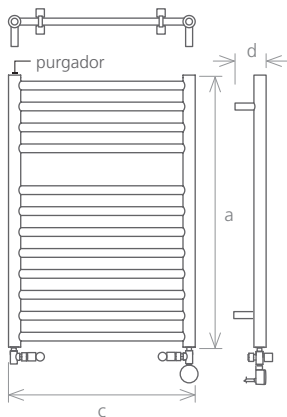

VERSÃO: AQUECIMENTO CENTRAL

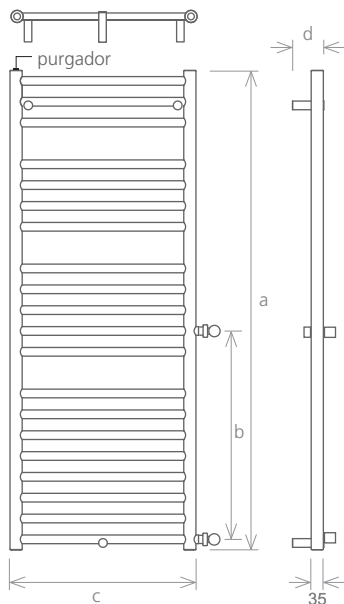

BL1400 IO (in&out) - Ligações laterais

BL1400E	BL1400L	BL1400XL	BL1400 IO	BL1800E	BL1800L	BL1800XL	modelo
1380	1380	1380	1380	1800	1800	1800	a (mm) altura
450	500	600	600	450	500	600	b (mm) distância entre eixos
485	535	635	535	485	535	635	c (mm) largura total
90	90	90	90	90	90	90	d (mm) profundidade
4,90	5,33	6,19	5,33	6,55	7,14	8,30	(l) capacidade
437,8	476,2	553,0	476,2	585,5	637,5	741,7	(W) aquecimento central
600	600	600	-	1000	1000	1000	(W) elétrico

**NOTA:**

**QUANDO NÃO IDENTIFICADO A POSIÇÃO DO ELEMENTO ELÉTRICO  
SERÁ SEMPRE COLOCADO DO LADO INFERIOR DIREITO**

**CORES RAL: cores sujeitas a confirmação.**

**BRANCO: RAL 9016 (RAL usado por definição)**

## DESIGN COLLECTION

DIAMOND	168
DIAMOND XS	172
ARENA	176
ARENA TABLE	182

# DIAMOND

DESIGN RADIATOR

DESIGNER: PATRICK PEDROSA

O Diamond surge no sentido de satisfazer as necessidades em equipamentos de climatização que partilhem de uma evolução e diferenciação conceitual dos espaços.

A sua valorização verifica-se na sua forma irregular e similaridade com as formas do diamante, cores e na sua capacidade de emissão calorífica.





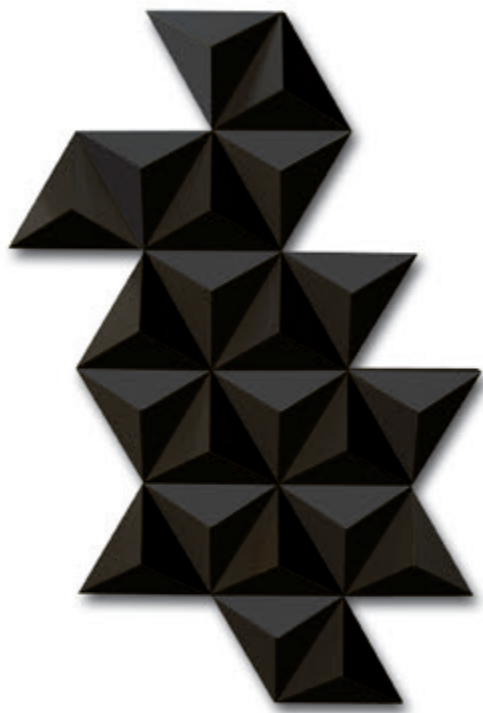





# DIAMOND XS

DESIGN RADIATOR

DESIGNER: PATRICK PEDROSA

OUTPUT MAX:  
2000 WATTS

electric  
element  
HIDDEN

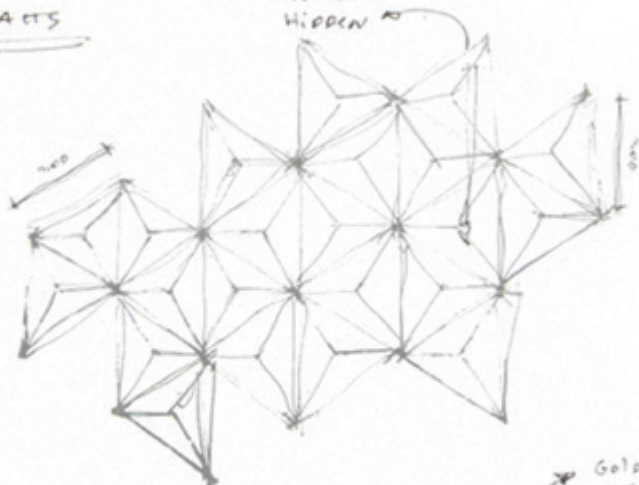

black  
white

Gold

Patrick Pedrosa MAY 2012

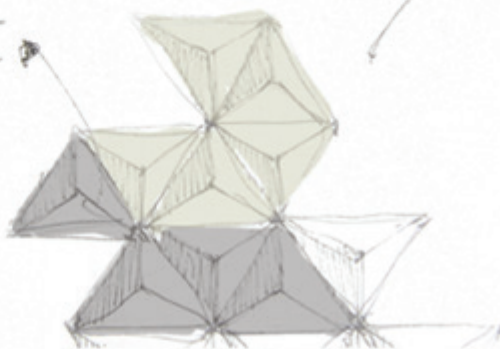

desenhos iniciais para a criação do Diamond



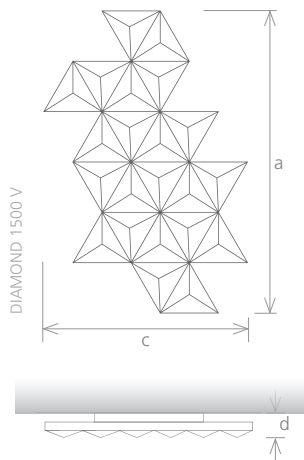
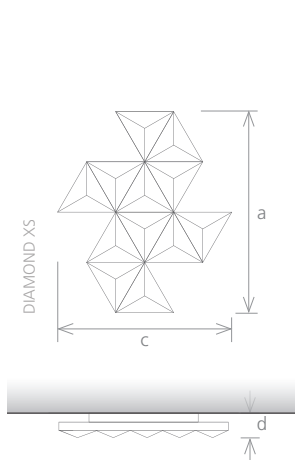

MATERIAL aço inox / aço carbono

ACABAMENTOS



ESCOVADO



FORJA



BRANCO



COR RAL

ACABAMENTO EM TITÂNIO \*



OURO



OURO VELHO



COBRE

VERSÃO: AQUECIMENTO CENTRAL

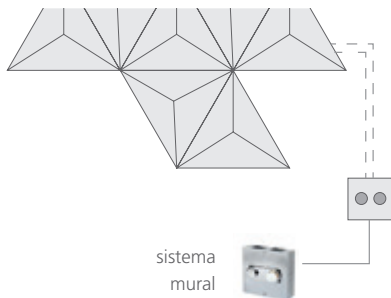

VERSÃO: ELÉTRICO II

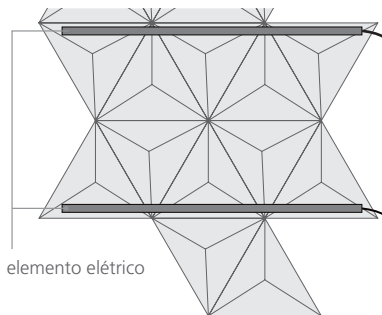

ACESSÓRIOS



KIT MURAL



MIMOO  
SWITCH



DOMOTIC  
TOUCH

modelo		D XS	D 1200H	D 1500V
altura (mm)	a	1040	1050	1560
distância entre eixos (mm)	b	50	50	50
largura total (mm)	c	900	1560	1050
profundidade (mm)	d	110	110	110
capacidade (l)		4,75	11,18	11,18
peso (kg)		≈ 35	≈ 75	≈ 75
aquecimento central (W)		568	1205	1205
elétrico (W)		600-1000	1600-2000	1600-2000

# ARENA

DESIGN RADIATOR

DESIGNER: PATRICK PEDROSA

O radiador Arena vem abordar o aquecimento de uma forma diferente.

De inspiração retro, apresenta-se como um elemento de decoração funcional e flexível, adaptável a espaços distintos.

O Arena poderá ser personalizado através da escolha e conjugação de diferentes materiais e acabamentos.



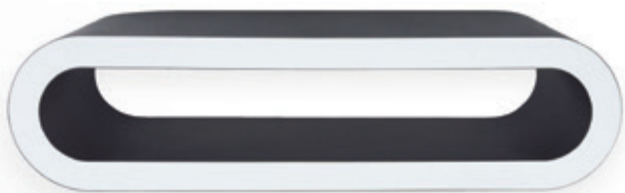

# ARENA

DESIGN RADIATOR



forja + branco



forja + branco



branco + polido



branco



forja

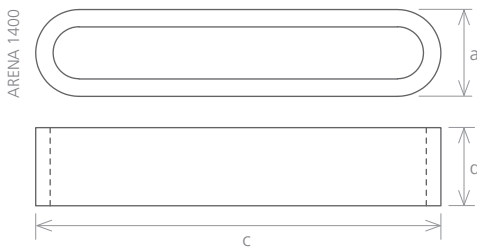
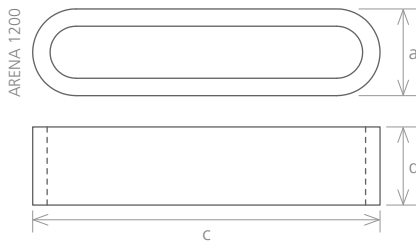
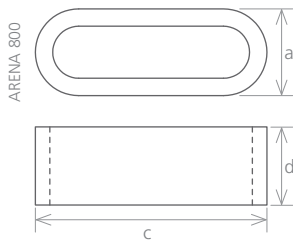

MATERIAL aço inox / aço carbono

ACABAMENTOS



POLIDO



ESCOVADO



FORJA



BRANCO



COR RAL



ACABAMENTO EM TITÂNIO \*



OURO



OURO VELHO



COBRE

VERSÃO: AQUECIMENTO CENTRAL

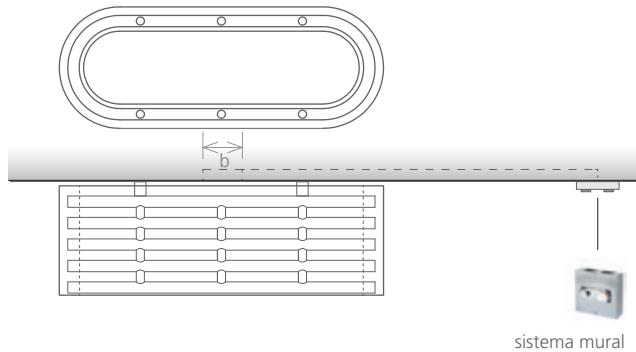

VERSÃO: ELÉTRICO II

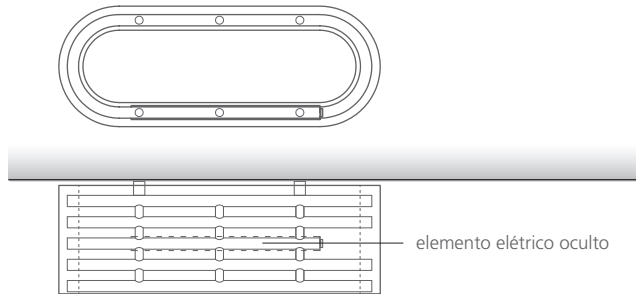

ACESSÓRIOS



KIT MURAL



MIMOO  
SWITCH



DOMOTIC  
TOUCH

modelo	A 800	A 1200	A 1400
altura (mm) a	300	300	300
distância entre eixos (mm) b	50	50	50
largura total (mm) c	800	1200	1400
profundidade (mm) d	270	270	270
capacidade (l)	5,32	7,78	9,04
peso (kg)	~30	~45	~55
aquecimento central (W)	578	801	913
elétrico (W)	600	1000	1400

# ARENA TABLE

DESIGN RADIATOR

DESIGNER: PATRICK PEDROSA

Design + Funcionalidade + Simplicidade = Arena Table

Estes são os motes que deram origem ao radiador elétrico Arena Table. Puro design associado à funcionalidade de aquecimento de diferentes espaços. A simplicidade e elegância das formas com inspiração retro tornam este radiador um elemento integrante da decoração de sua casa.



VERSÃO ELÉTRICA COM ELEMENTO II OCULTO

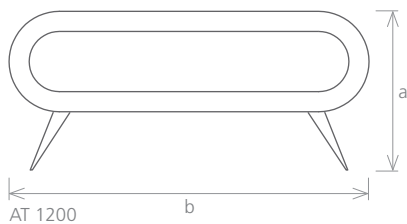
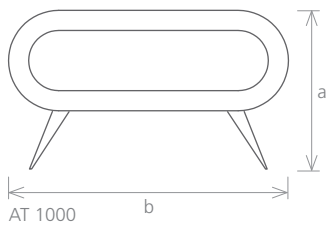

MATERIAL aço inox / aço carbono

ACABAMENTOS



POLIDO



ESCOVADO



FORJA



BRANCO



COR RAL

ACABAMENTO EM TITÂNIO \*



OURO



OURO VELHO



COBRE



VISTA DE FRENTE

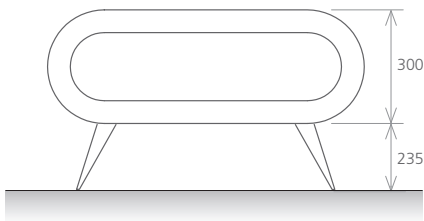

VISTA LATERAL

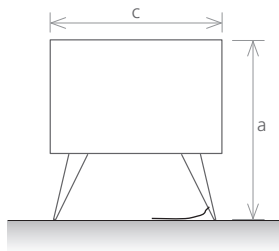

VISTA DE CIMA

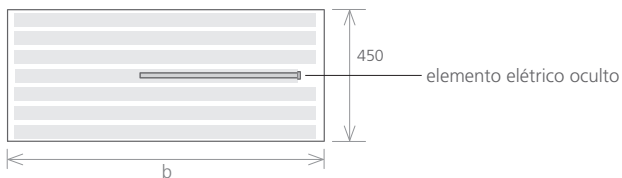

ACESSÓRIOS



KIT MURAL



MIMOO  
SWITCH



DOMOTIC  
TOUCH

modelo		AT 1000	AT 1200	AT 1400
altura (mm)	a	535	535	535
largura total (mm)	b	1000	1200	1400
profundidade (mm)	c	450	450	450
capacidade (l)		7,45	10,89	12,66
peso (kg)		~50	~65	~75
elétrico (W)		1000	1500	1500

**NOTA:**

**QUANDO NÃO IDENTIFICADO A POSIÇÃO DO ELEMENTO ELÉTRICO  
SERÁ SEMPRE COLOCADO DO LADO INFERIOR DIREITO**

**CORES RAL: cores sujeitas a confirmação.**

**BRANCO: RAL 9016 (RAL usado por definição)**

## ROOM RADIATORS

CURVE	188
D LIGNE	194
DIVINE	200
LINEAR	206
PLANO MOVE	212
PLANO PURE	218
PLANO PURE ON/OFF	224
PLANO +	226
PLANO	232

# CURVE

ROOM RADIATOR

O novo e extraordinário radiador de design desenvolvido pela Foursteel®, de linhas modernas e simples para espaços interiores de ambiente cosmopolita, fabricado na versão eléctrica ou de aquecimento central.



# CURVE



MATERIAL aço inox / aço carbono

## ACABAMENTOS



POLIDO



ESCOVADO



FORJA



BRANCO



COR RAL

## ACESSÓRIOS



KIT MURAL



MIMOO  
SWITCH



DOMOTIC  
TOUCH

VERSÃO ELÉTRICA COM ELEMENTO II OCULTO

VISTA DE FRENTE

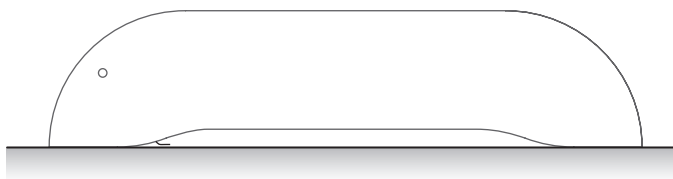

interruptor on/off com LED  
voltagem AC 230v

VISTA LATERAL

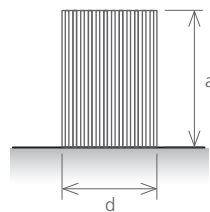

VISTA DE CIMA

modelo		C2301000	C2301500	C2302000	C3001000	C3001500	C3002000
altura (mm)	a	230	230	230	300	300	300
comprimento total (mm)	b	1000	1500	2000	1000	1500	2000
profundidade (mm)	c	160	160	160	160	160	160
capacidade (L)		1,3	2,1	2,9	1,3	2,1	2,9
elétrico (W)		1600	1800	2000	1600	1800	2000

# CURVE





VERSÃO: AQUECIMENTO CENTRAL

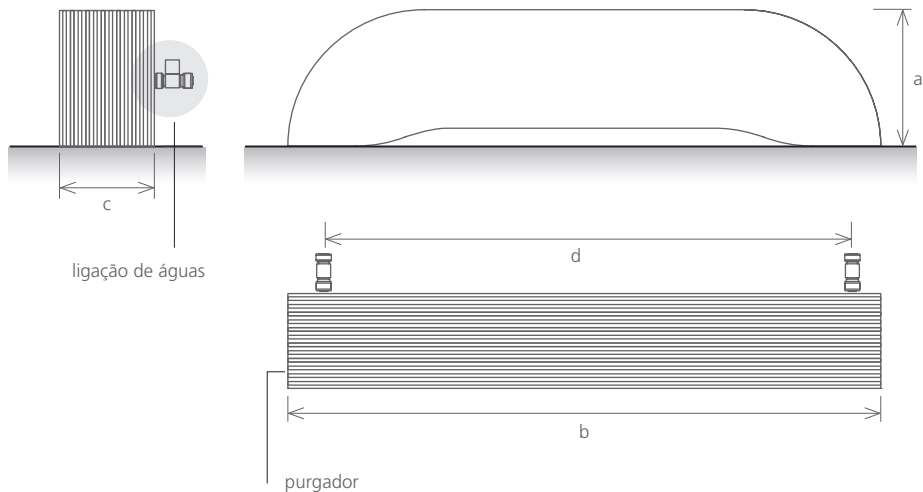

solução 1

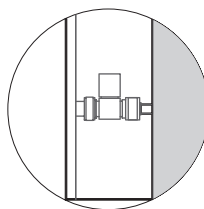

solução 2

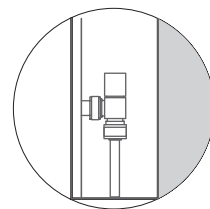

modelo		C2301000	C2301500	C2302000	C3001000	C3001500	C3002000
altura (mm)	a	230	230	230	300	300	300
comprimento total (mm)	b	1000	1500	2000	1000	1500	2000
profundidade (mm)	c	160	160	160	160	160	160
distância entre eixos (mm)	d	800	1300	1800	800	1300	1800
aquecimento central (W)		872	1343	1787	1308	2015	2480

# D LIGNE

RADIATOR

No segmento de radiadores de chão desenvolvidos pela Foursteel®, o radiador D Ligne apresenta-se glamouroso e requintado para espaços elegantes e contemporâneos. Disponível na versão eléctrica e em aquecimento central.



# D LIGNE



MATERIAL aço inox / aço carbono

## ACABAMENTOS



POLIDO



ESCOVADO



FORJA



BRANCO



COR RAL



## ACESSÓRIOS



KIT MURAL



MIMOO  
SWITCH



DOMOTIC  
TOUCH

## VERSÃO ELÉTRICA COM ELEMENTO II OCULTO

VISTA DE FRENTE

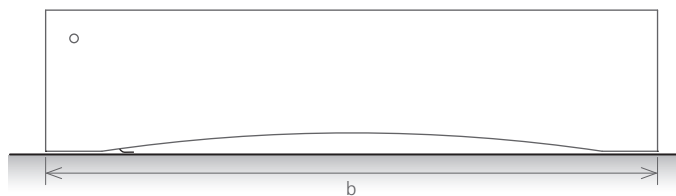

interruptor on/off com LED  
voltagem AC 230v

VISTA LATERAL

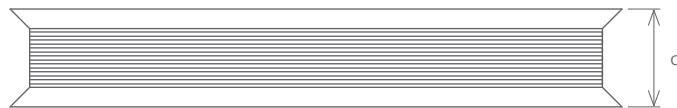
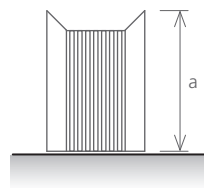

VISTA DE CIMA

modelo	DL2301000	DL2301500	DL2302000	DL3001000	DL3001500	DL3002000
altura (mm) a	230	230	230	300	300	300
comprimento total (mm) b	1000	1500	2000	1000	1500	2000
profundidade (mm) c	160	160	160	160	160	160
capacidade (L)	1,4	2,2	3,0	1,4	2,2	3,0
elétrico (W)	1600	1800	2000	1600	1800	2000

VERSÃO: AQUECIMENTO CENTRAL

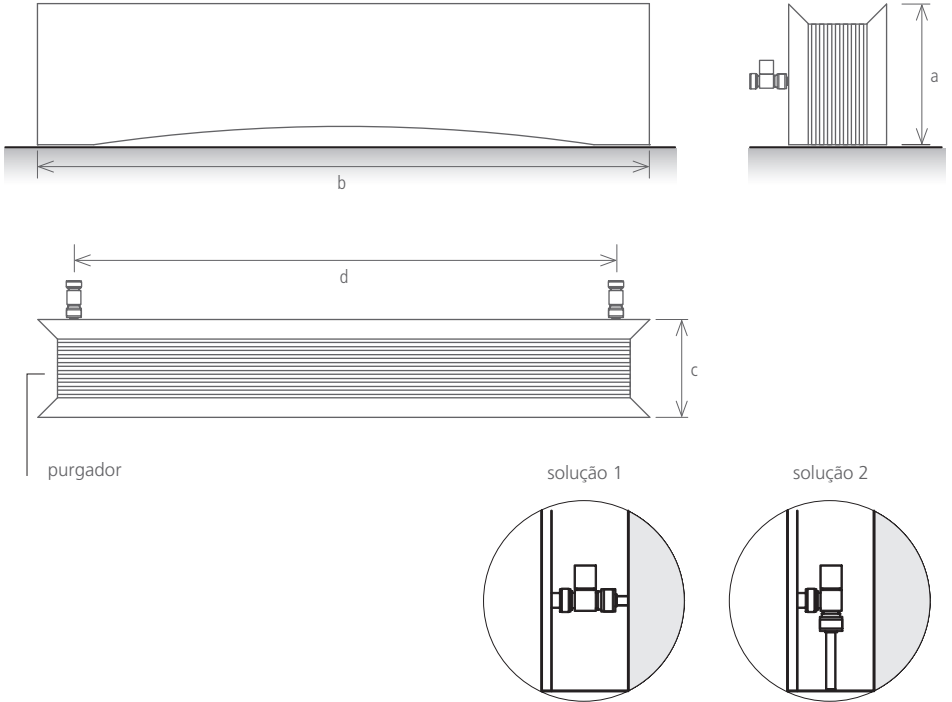

modelo		DL2301000	DL2301500	DL2302000	DL3001000	DL3001500	DL3002000
altura (mm)	a	230	230	230	300	300	300
comprimento total (mm)	b	1000	1500	2000	1000	1500	2000
profundidade (mm)	c	160	160	160	160	160	160
distância entre eixos (mm)	d	880	1380	1880	880	1380	1880
aquecimento central (W)		948	1460	1942	1422	2190	2913

# DIVINE

RADIATOR

Contemporâneo, funcional e discreto, o Divine surge como um radiador de fácil mobilidade, adaptável ao conforto do espaço em que se insere.





# DIVINE

RADIATOR



## VERSÃO ELÉTRICA COM ELEMENTO II OCULTO

VISTA LATERAL

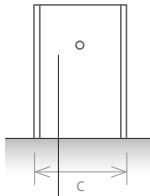

VISTA DE FRENTE

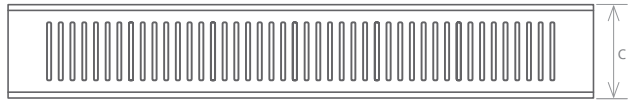
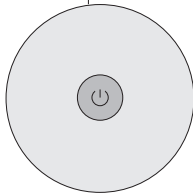
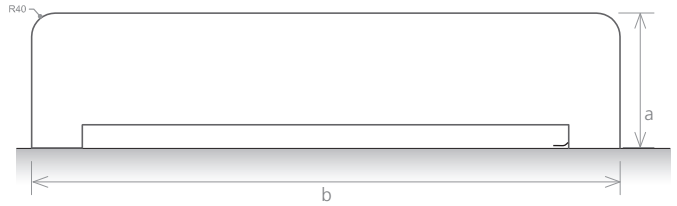

VISTA DE CIMA

interruptor on/off com LED  
voltagem AC 230v

modelo		DI 1000	DI 1500	DI 2000	DI30 1000	DI30 1500	DI30 2000
altura (mm)	a	230	230	230	300	300	300
comprimento total (mm)	b	1000	1500	2000	1000	1500	2000
profundidade (mm)	c	160	160	160	160	160	160
capacidade (L)		1,4	2,2	3,0	1,4	2,2	3,0
elétrico (W)		1600	1800	2000	1600	1800	2000

VERSÃO: AQUECIMENTO CENTRAL

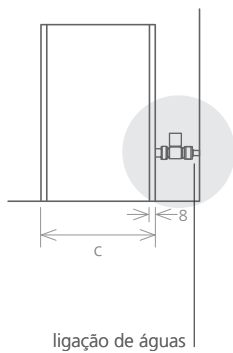

solução 1

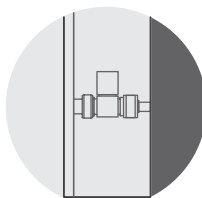

solução 2

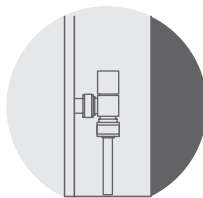

MATERIAL aço inox / aço carbono

ACABAMENTOS



ACESSÓRIOS



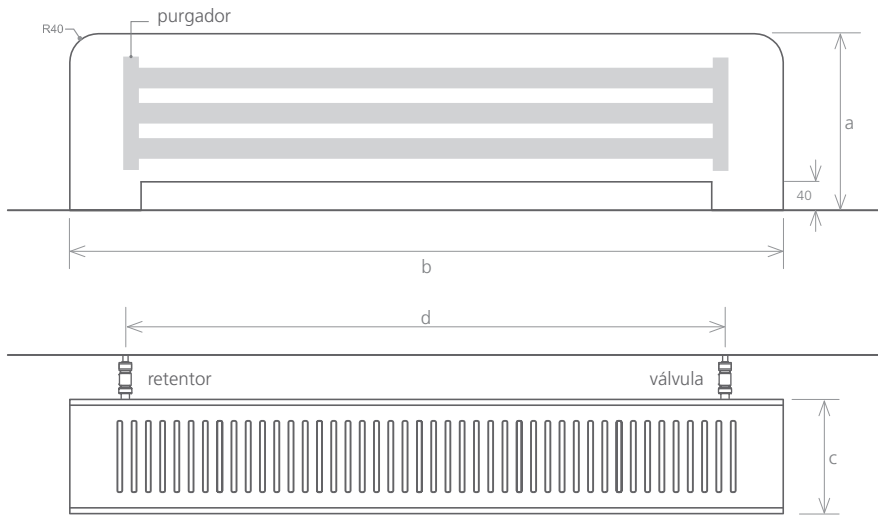

modelo		DI 1000	DI 1500	DI 2000	DI30 1000	DI30 1500	DI30 2000
altura (mm)	a	230	230	230	300	300	300
comprimento total (mm)	b	1000	1500	2000	1000	1500	2000
profundidade (mm)	c	160	160	160	160	160	160
distância entre eixos (mm)	d	880	1380	1880	880	1380	1880
aquecimento central (W)		948	1460	1942	1422	2190	2913

# LINEAR

## RADIADOR

O radiador Linear caracteriza-se pelo seu alto desempenho calorífico adaptando-se a qualquer espaço.

Está disponível em aço inox e aço carbono, nos acabamentos: branco, forja, polido e escovado.

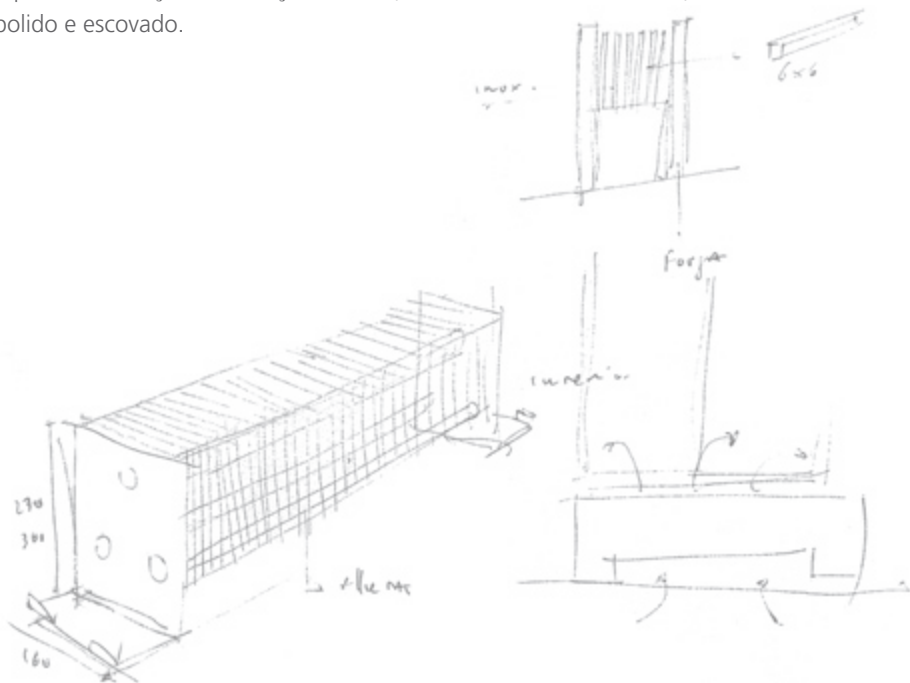





MATERIAL aço inox / aço carbono

#### ACABAMENTOS



POLIDO



ESCOVADO



FORJA



BRANCO



COR RAL





---

ACESSÓRIOS



KIT MURAL



MIMOO  
SWITCH



DOMOTIC  
TOUCH

VERSÃO: ELÉTRICA COM ELEMENTO II OCULTO

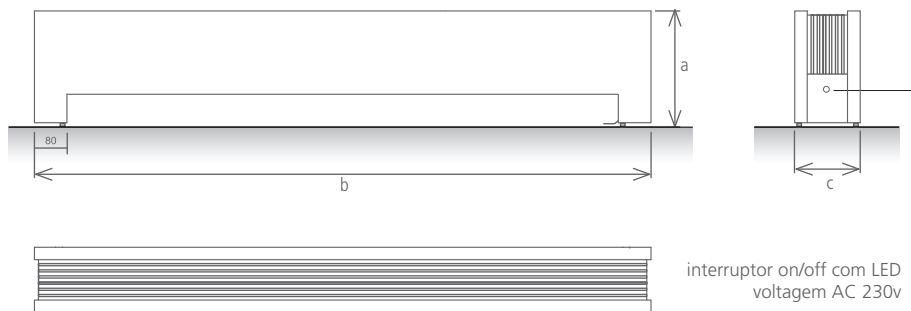

interruptor on/off com LED  
voltagem AC 230v

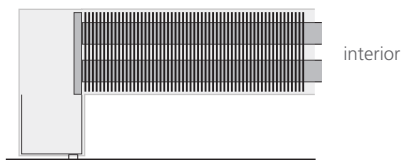

modelo		LE 1000	LE 1500	LE 1000+	LE 1500+	LE 2000+	LE30 1000	LE30 1500	LE30 2000
altura (mm)	a	240	240	240	240	240	310	310	310
comprimento total (mm)	b	1000	1500	1000	1500	2000	1000	1500	2000
profundidade (mm)	c	100	100	160	160	160	160	160	160
capacidade (L)		1,4	2,2	1,4	2,2	3,0	1,4	2,2	3,0
elétrico (W)		1600	1800	1600	1800	2000	1600	1800	2000

VERSÃO: AQUECIMENTO CENTRAL

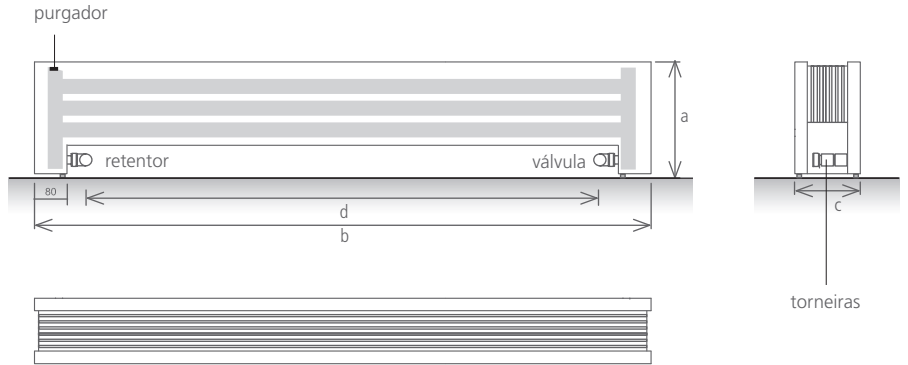

solução 1

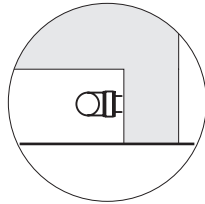

solução 2

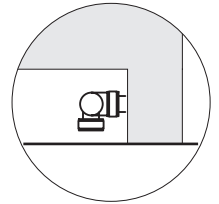

modelo		LC 1000	LC 1500	LC 2000	LC30 1000	LC30 1500	LC30 2000
altura (mm)	a	240	240	240	310	310	310
comprimento total (mm)	b	1000	1500	2000	1000	1500	2000
profundidade (mm)	c	160	160	160	160	160	160
distância entre eixos (mm)	d	-	-	-	-	-	-
aquecimento central (W)		948	1460	1942	1422	2190	2913

# PLANO MOVE

RADIADOR

De conceito minimalista o Plano Move apresenta-se como a nova aposta para a climatização do seu espaço. O Plano Move funciona como seca-toalhas e/ou radiador é adaptável a diferentes espaços, bem como a diferentes medidas.

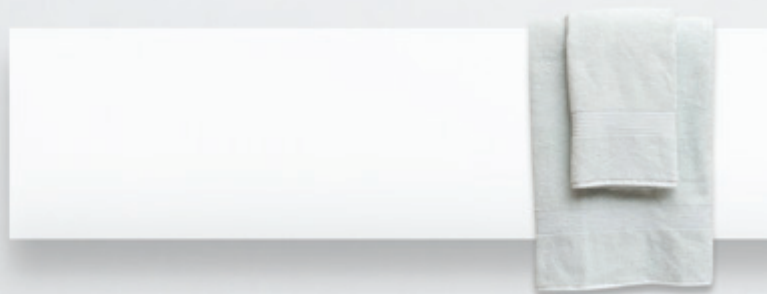

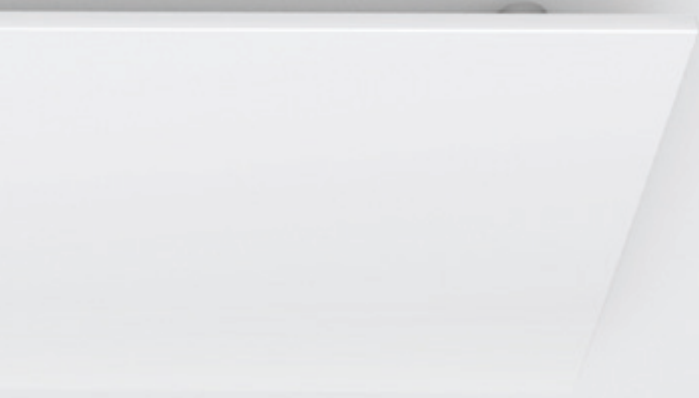

MATERIAL aço inox / aço carbono

ACABAMENTOS



POLIDO



ESCOVADO



FORJA



BRANCO



COR RAL

ACESSÓRIOS



MIMOO  
SWITCH



DOMOTIC  
TOUCH



VERSÃO: ELÉTRICA COM ELEMENTO II OCULTO

VISTA DE FRENTE



VISTA LATERAL



elemento elétrico oculto

**NOTA :** Elemento elétrico com fluido térmico

modelo	PM400 800	PM500 800	PM600 800	PM400 1200	PM500 1200	PM600 1200	PM400 1400
altura (mm) a	400	500	600	400	500	600	400
largura total (mm) c	800	800	800	1200	1200	1200	1400
profundidade (mm) d	40 / 60 / 90	40 / 60 / 90	40 / 60 / 90	40 / 60 / 90	40 / 60 / 90	40 / 60 / 90	40 / 60 / 90
elétrico (W)	300	300	600	600	600	600	300

modelo	PM800 400	PM800 500	PM800 600	PM1200 400	PM1200 500	PM1200 600	PM1400 400
altura (mm) a	800	800	800	1200	1200	1200	1400
largura total (mm) c	400	500	600	400	500	600	400
profundidade (mm) d	40 / 60 / 90	40 / 60 / 90	40 / 60 / 90	40 / 60 / 90	40 / 60 / 90	40 / 60 / 90	40 / 60 / 90
elétrico (W)	300	300	600	600	600	600	300



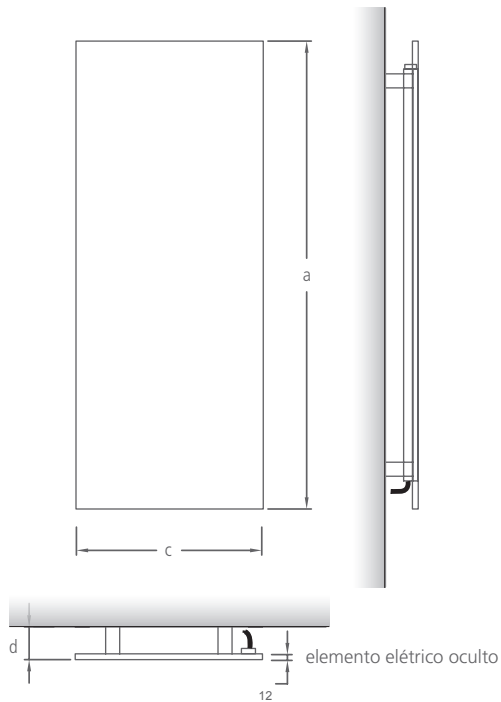

**NOTA :** Elemento elétrico com fluído térmico

PM500 1400	PM600 1400	PM400 1800	PM500 1800	PM600 1800	PM400 2000	PM500 2000	PM600 2000
500	600	400	500	600	400	500	600
1400	1400	1800	1800	1800	2000	2000	2000
40 / 60 / 90	40 / 60 / 90	40 / 60 / 90	40 / 60 / 90	40 / 60 / 90	40 / 60 / 90	40 / 60 / 90	40 / 60 / 90
300	600	600	600	1000	1000	1000	1000

PM1400 500	PM1400 600	PM1800 400	PM1800 500	PM1800 600	PM2000 400	PM2000 500	PM2000 600
1400	1400	1800	1800	1800	2000	2000	2000
500	600	400	500	600	400	500	600
40 / 60 / 90	40 / 60 / 90	40 / 60 / 90	40 / 60 / 90	40 / 60 / 90	40 / 60 / 90	40 / 60 / 90	40 / 60 / 90
300	600	600	600	1000	1000	1000	1000

# PLANO PURE

RADIADOR

O Plano Pure é um radiador com design minimalista que se adapta a qualquer ambiente, permitindo uma linguagem limpa e sóbria.

Encontra-se disponível na versão de aquecimento central e na versão elétrica.

Além dos acabamentos standard também disponível em cores RAL.





versão elétrica com elemento II oculto com suporte de tolas

MATERIAL aço inox / aço carbono

#### ACABAMENTOS



POLIDO



ESCOVADO



FORJA



BRANCO



COR RAL

#### ACESSÓRIOS



KIT MURAL



MIMOO  
SWITCH



DOMOTIC  
TOUCH



VERSÃO: ELÉTRICA II

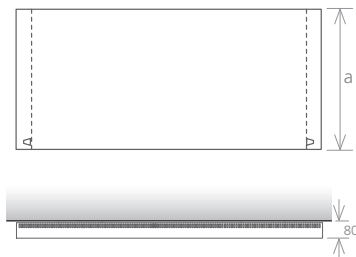

VERSÃO: ELÉTRICA II

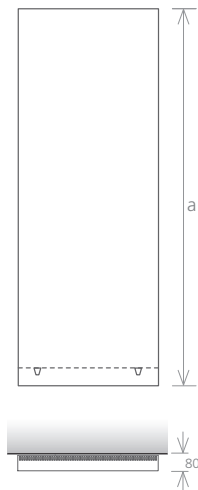



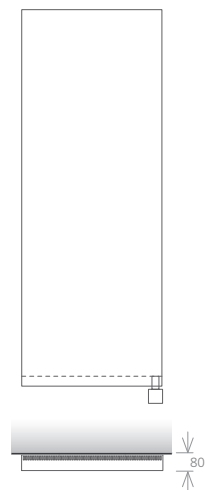

VERSÃO: ELÉTRICA IV



\* Diferentes posições entre eixos das torneiras à escolha do cliente.

\*\* A profundidade pode ser inferior a 80mm.

**NOTA :** Elemento elétrico com fluido térmico

					
	modelo	PP 650 1200	PP 650 1800	PP 650 2000	PP 1000 1000
	altura (mm) a	650	650	650	1000
*	distância entre eixos (mm) b	-	-	-	-
	largura total (mm) c	1200	1800	2000	1000
**	profundidade (mm) d	80	80	80	80
	capacidade (l)	26,03	33,31	36,99	28,96
	peso (kg)	47,4	69,8	77,1	64,6
	aquecimento central (W)	2512	3768	4187	3382
	elétrico II (W)	1200	1600	2000	1200
	elétrico IV (W)	-	-	-	-

VERSÃO: AQUECIMENTO CENTRAL

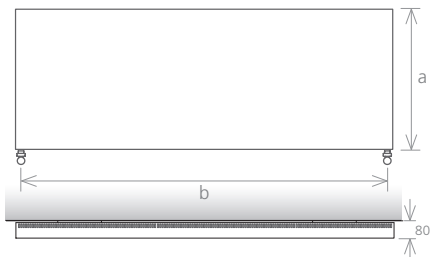

VERSÃO: AQUECIMENTO CENTRAL

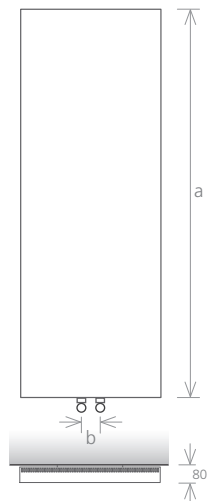

\* Diferentes posições entre eixos das torneiras à escolha do cliente.

\*\* A profundidade pode ser inferior a 80mm.

**NOTA** : Elemento elétrico com fluido térmico

PP 1800 550	PP 2000 550	PP 1800 650	PP 2000 650
1800	2000	1800	2000
-	-	-	-
550	550	650	650
80	80	80	80
27,88	28,96	33,31	36,99
59,1	75,2	69,8	77,1
3267	3630	3768	4187
1600	2000	1600	2000
1000	1000	1000	1000

	modelo
a (mm)	altura
b (mm)	distância entre eixos *
c (mm)	largura total
d (mm)	profundidade **
(l)	capacidade
(kg)	peso
(W)	aquecimento central
(W)	elétrico II
(W)	elétrico IV



# PLANO PURE ON/OFF

RADIADOR





# PLANO +

## RADIADOR

O radiador Plano +, devido à forma e posicionamento dos elementos de pequena espessura, permite uma elevada performance térmica.





MATERIAL aço inox / aço carbono

#### ACABAMENTOS



POLIDO



ESCOVADO



FORJA



BRANCO



COR RAL



\* Diferentes posições entre eixos das torneiras à escolha do cliente.

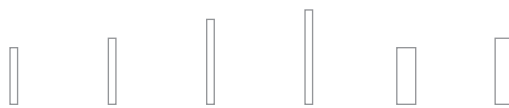



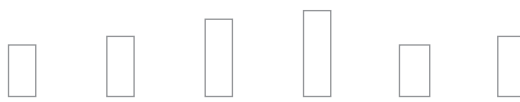



modelo	P+1200 10	P+1400 10	P+1800 10	P+2000 10	P+1200 25	P+1400 25
nº de elementos	10	10	10	10	25	25
altura (mm)	1200	1400	1800	2000	1200	1400
largura total (mm)	210	210	210	210	510	510
profundidade (mm)	120	120	120	120	120	120
capacidade (l)	4,25	4,91	6,23	6,89	10,61	12,26
peso (kg)	17,14	19,90	25,42	28,18	42,81	49,71
aquec. central (W)	782	901	1136	1256	1960	2259

















modelo	P+1200 36	P+1400 36	P+1800 36	P+2000 36	P+1200 40	P+1400 40
nº de elementos	36	36	36	36	40	40
altura (mm)	1200	1400	1800	2000	1200	1400
largura total (mm)	730	730	730	730	810	810
profundidade (mm)	120	120	120	120	120	120
capacidade (l)	15,28	17,65	22,38	24,75	16,97	19,60
peso (kg)	61,64	71,57	91,45	101,38	68,48	79,52
aquec. central (W)	2826	3257	4099	4530	3139	3619



modelo	P+25 1200	P+25 1400	P+25 1800	P+31 1200	P+31 1400	P+31 1800	P+36 1200
nº de elementos	25	25	25	31	31	31	36
altura (mm)	510	510	510	630	630	630	730
largura total (mm)	1200	1400	1800	1200	1400	1800	1200
profundidade (mm)	120	120	120	120	120	120	120
capacidade (l)	10,61	12,26	15,55	13,16	15,20	19,28	15,28
peso (kg)	42,81	49,71	63,51	53,08	61,64	78,75	61,64
aquec. central (W)	1960	2259	2845	2432	2801	3157	2826

						modelo
P+1800 25	P+2000 25	P+1200 31	P+1400 31	P+1800 31	P+2000 31	nº de elementos
25	25	31	31	31	31	(mm) altura
1800	2000	1200	1400	1800	2000	(mm) largura total
510	510	630	630	630	630	(mm) profundidade
120	120	120	120	120	120	(l) capacidade
15,55	17,19	13,16	15,20	19,28	21,32	(kg) peso
63,51	70,41	53,08	61,64	78,75	87,31	(W) aquec. central
2845	3146	2432	2801	3157	3902	

						modelo
P+1800 40	P+2000 40	P+1200 60	P+1400 60	P+1800 60	P+2000 60	nº de elementos
40	40	60	60	60	60	(mm) altura
1800	2000	1200	1400	1800	2000	(mm) largura total
810	810	1210	1210	1210	1210	(mm) profundidade
120	120	120	120	120	120	(l) capacidade
24,87	27,50	25,45	29,40	37,30	41,24	(kg) peso
101,60	112,71	102,71	119,27	152,39	168,95	(W) aquec. central
4557	5030	4706	5427	6820	7520	

								modelo
P+36 1400	P+36 1800	P+40 1200	P+40 1400	P+40 1800	P+60 1200	P+60 1400	P+60 1800	nº de elementos
36	36	40	40	40	60	60	60	(mm) altura
730	730	810	810	810	1210	1210	1210	(mm) largura total
1400	1800	1200	1400	1800	1200	1400	1800	(mm) profundidade
120	120	120	120	120	120	120	120	(l) capacidade
17,65	22,38	16,97	19,60	24,87	25,45	29,40	37,30	(kg) peso
71,57	91,45	68,48	79,52	101,60	102,71	119,27	152,39	(W) aquec. central
3257	4099	3139	3619	4557	4706	5427	6820	

# PLANO

RADIADOR

A sobriedade e linhas direitas do radiador Plano complementam o ambiente independentemente do espaço onde é integrado.

Com o complemento de acessórios usufrua na sua plenitude do radiador Plano.





versão elétrica com elemento II

# PLANO

RADIADOR

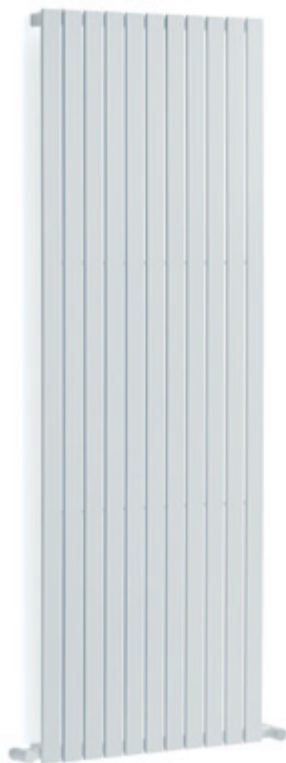

MATERIAL aço inox / aço carbono

## ACABAMENTOS



POLIDO



ESCOVADO



FORJA



BRANCO



COR RAL

## ACESSÓRIOS



KIT MURAL



MIMOO  
SWITCH



















DOMOTIC  
TOUCH



















versão de aquecimento central





\* Diferentes posições entre eixos das torneiras à escolha do cliente.







								
modelo	P1200 4	P1400 4	P1800 4	P2000 4	P1200 8	P1400 8	P1800 8	P2000 8
nº de elementos	4	4	4	4	8	8	8	8
altura (mm)	1200	1400	1800	2000	1200	1400	1800	2000
largura total (mm)	221	221	221	221	449	449	449	449
profundidade (mm)	85	85	85	85	85	85	85	85
capacidade (l)	2,01	2,29	2,98	3,25	4,10	4,70	5,98	6,32
peso (kg)	7,24	8,34	10,55	11,65	14,49	16,70	21,12	23,32
aquec. central (W)	325	379	469	497	654	733	925	956
elétrico (W)	600	600	600	600	1000	1000	1000	1000

								
modelo	P1200 11	P1400 11	P1800 11	P2000 11	P1200 14	P1400 14	P1800 14	P2000 14
nº de elementos	11	11	11	11	14	14	14	14
altura (mm)	1200	1400	1800	2000	1200	1400	1800	2000
largura total (mm)	620	620	620	620	791	791	791	791
profundidade (mm)	85	85	85	85	85	85	85	85
capacidade (l)	5,71	6,51	8,26	8,74	6,68	7,60	9,44	10,37
peso (kg)	19,93	22,97	29,04	32,08	25,38	29,24	36,97	40,83
aquec. central (W)	864	997	1262	1388	1106	1276	1594	1603
elétrico (W)	1600	2000	2000	2000	2000	2000	2000	2000

								
modelo	P9 1200	P9 1400	P9 1800	P10 1200	P10 1400	P10 1800	P11 1200	P11 1400
nº de elementos	9	9	9	10	10	10	11	11
altura (mm)	506	506	506	563	563	563	620	620
largura total (mm)	1200	1400	1800	1200	1400	1800	1200	1400
profundidade (mm)	85	85	85	85	85	85	85	85
capacidade (l)	4,54	5,30	6,69	5,11	5,97	7,44	5,71	6,51
peso (kg)	16,31	18,79	23,76	18,12	20,88	26,40	19,93	22,97
aquec. central (W)	713	829	1002	814	933	1142	864	997
elétrico (W)	1200	1200	1200	1200	1200	1200	1200	1600

								modelo
P1200 9	P1400 9	P1800 9	P2000 9	P1200 10	P1400 10	P1800 10	P2000 10	nº de elementos
9	9	9	9	10	10	10	10	(mm) altura
1200	1400	1800	2000	1200	1400	1800	2000	(mm) largura total
506	506	506	506	563	563	563	563	(mm) profundidade
85	85	85	85	85	85	85	85	(l) capacidade
4,54	5,30	6,69	7,21	5,11	5,97	7,44	8,10	(kg) peso
16,31	18,79	23,76	26,24	18,12	20,88	26,40	29,16	(W) aquec. central
713	829	1022	1117	814	933	1142	1263	(W) elétrico
1200	1600	2000	2000	1200	1200	2000	2000	

				modelo
P1200 21	P1400 21	P1800 21	P2000 21	nº de elementos
21	21	21	21	(mm) altura
1200	1400	1800	2000	(mm) largura total
1190	1190	1190	1190	(mm) profundidade
85	85	85	85	(l) capacidade
10,03	11,41	14,17	15,55	(kg) peso
38,07	43,87	55,46	62,55	(W) aquec. central
1649	1899	2390	2641	(W) elétrico
2000	2000	2000	2000	

							modelo
P11 1800	P14 1200	P14 1400	P14 1800	P21 1200	P21 1400	P21 1800	nº de elementos
11	14	14	14	21	21	21	(mm) altura
620	791	791	791	1190	1190	1190	(mm) largura total
1800	1200	1400	1800	1200	1400	1800	(mm) profundidade
85	85	85	85	85	85	85	(l) capacidade
8,26	6,68	7,60	9,44	10,03	11,41	14,17	(kg) peso
29,04	25,38	29,24	36,97	38,07	43,87	55,46	(watt) aquec. central
1262	1106	1276	1594	1649	1899	2390	(watt) elétrico
2000	1600	1600	2000	1600	2000	2000	



## ACESSÓRIOS

DOMOTIC TOUCH	240
MIMOO SWITCH	244
ELEMENTOS ELÉTRICOS	246
VÁLVULAS E RETENTORES	248
OUTROS ACESSÓRIOS	256

# DOMOTIC TOUCH

## TECNOLOGIA

Domotic Touch é uma solução simples com parâmetros de instalação de um simples interruptor.

### Funcionalidade económica

Aumenta a eficiência energética através da programação do número de horas de funcionamento (uma, duas ou três horas).

### Funcionalidade conforto

Permite a racionalização dos gastos de energia pela funcionalidade de controlo de temperatura (18°C, 20°C, 22°C, 24°C).

Com o seu sensor de temperatura de leitura ambiente esta funcionalidade permite selecionar a temperatura desejada para o seu conforto no espaço de banho.

### Flexibilidade

A domótica permite a gestão de um ou mais radiadores ou toalheiros elétricos para o mesmo espaço de banho.



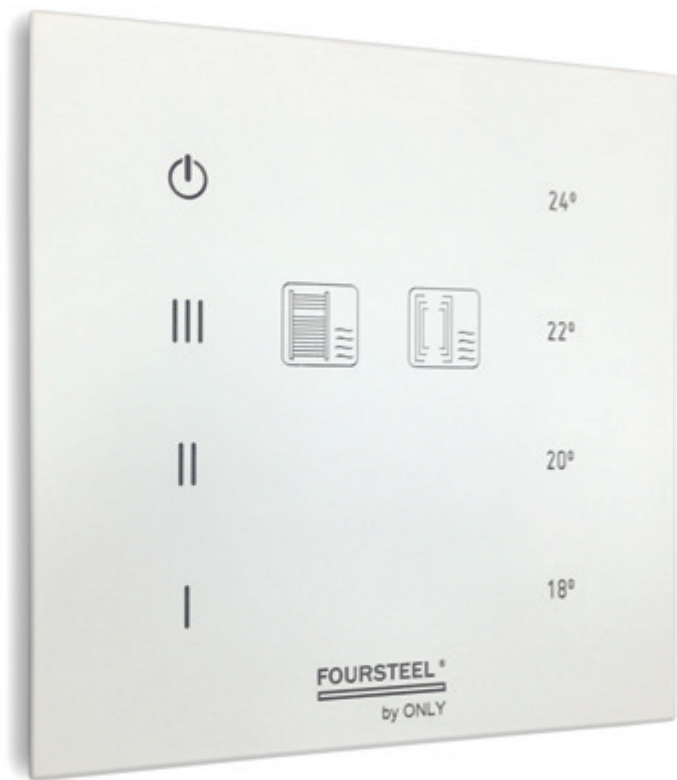

90mm x 90mm x 5mm  
IP44

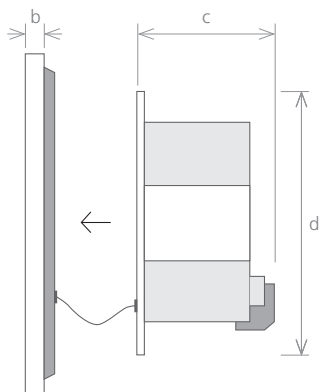

elemento 1 elemento 2

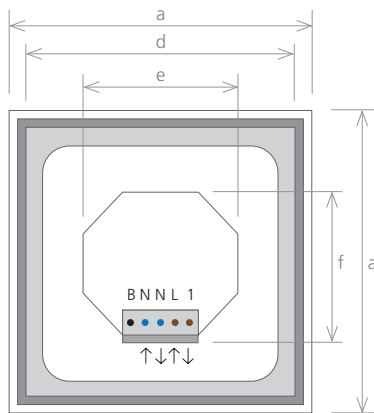

- B -
- N entrada neutro
- N saída neutro radiador toalheiro
- L entrada fase
- 1 saída fase radiador toalheiro

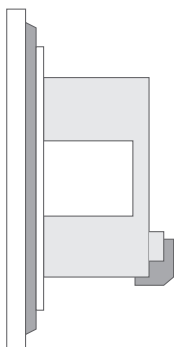

elemento 1 + 2

	modelo	DT
medida total exterior (mm)	a	90 x 90
espessura exterior (mm)	b	5
profundidade da caixa interior (mm)	c	40
medida total interior (mm)	d	73 x 73
medida horizontal posterior (mm)	e	55
medida vertical posterior (mm)	f	51

# DOMOTIC TOUCH

TECNOLOGIA



## MIMOO SWITCH

A Foursteel apresenta um novo dispositivo para que possa controlar o seu toalheiro ou radiador. Totalmente em aço inox, o seu conceito minimalista enquadra-se com todos os produtos de aquecimento elétrico da Foursteel.





DOURADO ESCOVADO



DOURADO POLIDO



COBRE ESCOVADO



COBRE POLIDO



ESCOVADO



POLIDO









FORJA



BRANCO

# ELEMENTOS ELÉTRICOS

						
classe	1	2	1	2	2	2
IP	IP X4	IP64 / IP67*	IP 64	IP X5	IP X4	IP X4
orientação vertical	●	●	●	●	●	●
orientação horizontal		●		●		
on / off	●		●	●	●	●
regulador de temperatura	●		●	●	●	●
temporizador 2h				●	●	●
leitura ambiente				●		●
programável						●

\* somente elementos elétricos de 40W

### ELEMENTO ELÉTRICO I

só disponível para Portugal



CROMADO

CINZENTO

BRANCO

### ELEMENTO ELÉTRICO II

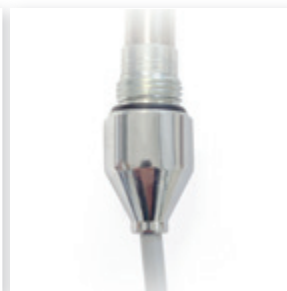

standard

### ELEMENTO ELÉTRICO III

só disponível para Portugal



CROMADO

CINZENTO

BRANCO

### ELEMENTO ELÉTRICO IV



CROMADO

CINZENTO

### ELEMENTO ELÉTRICO V



CROMADO

### ELEMENTO ELÉTRICO VI



CROMADO

# VÁLVULAS E RETENTORES

acessórios



## KIT TORNEIRAS 1

Válvula manual esquadria quadrada

Retentor manual esquadria quadrada

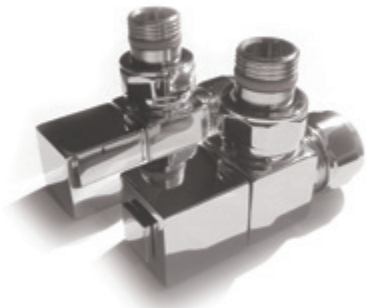

CROMADO

ESCOVADO

BRANCO

FORJA

## KIT TORNEIRAS 2

Válvula manual esquadria quadrada

Retentor manual esquadria quadrada



CROMADO

ESCOVADO

### KIT TORNEIRAS 3

Válvula e retentor manual esquadria redonda



CROMADO

Válvula e retentor manual esquadria redonda



ESCOVADO

### KIT TORNEIRAS 4

Válvula e retentor manual esquadria redonda



CROMADO

Válvula e retentor manual esquadria redonda



ESCOVADO

Válvula e retentor manual esquadria redonda



BRANCO

PRETO

Válvula e retentor manual esquadria redonda



BRANCO

PRETO

## KIT TORNEIRAS 5

Válvula manual Rewind



CROMADO



ESCOVADO

Válvula manual Rewind  
estilo francês



CROMADO



ESCOVADO

## KIT TORNEIRAS 6

Válvula e retentor manual diretos



CROMADO



ESCOVADO

Válvula e retentor manual diretos



BRANCO

Válvula manual Rewind  
estilo inglês



CROMADO



ESCOVADO

\* Deve comprar duas unidades de válvulas por radiador.

## KIT TORNEIRAS 7

Válvula e retentor manual esquadria redonda



CROMADO



ESCOVADO



CROMADO



ESCOVADO

## KIT TERMOSTÁTICO 1

Válvula termostática

Retentor



CROMADO



ESCOVADO



BRANCO

## KIT TERMOSTÁTICO 2

Válvula com cabeça termostática

Retentor



CROMADO



ESCOVADO



CROMADO



ESCOVADO

## Cabeça termostática + Capeamento



CROMADO ESCOVADO BRANCO



CROMADO ESCOVADO BRANCO

## KIT MURAL 1

Torneiras termostáticas



CROMADO ESCOVADO

# OUTROS ACESSÓRIOS

## ADAPTADOR MISTO

Adaptador meia esquadria para versão mista



CROMADO ESCOVADO BRANCO

Adaptador meia esquadria para versão mista



CROMADO ESCOVADO BRANCO



## SUportes

Suporte I



CROMADO



ESCOVADO

Suporte II



CROMADO



ESCOVADO

## PURGADORES

purgador 1/2"

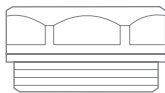

CROMADO

purgador 1/8"

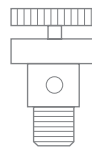

CROMADO

**NOTA** : Todos os nossos radiadores elétrico são compostos por elemento elétrico e fluido térmico.

## **FOURSTEEL**®

[ heating products factory ]

Foursteel - Produtos em Inox, Lda

Centro Empresarial de Aveiro

Zona Industrial de Mamodeiro

3811-783 Aveiro

PORTUGAL

T +351 234 940 458

F +351 234 940 414

geral@foursteel.eu

www.foursteel.eu





**FOURSTEEL®**  
[ heating products factory ]

[www.foursteel.eu](http://www.foursteel.eu)